



**Endosystem**

ul. Piłsudskiego 75c

05-200 Wołomin

tel. +48 503 99 25 85

tel./fax +48 22 776 80 41

[endosystem@endosystem.pl](mailto:endosystem@endosystem.pl)

[www.endosystem.pl](http://www.endosystem.pl)



**REMA**  
SURGERY



**Arthroscopy**  
Arthroskopie  
Artroscopia



**ARTHROSCOPY**

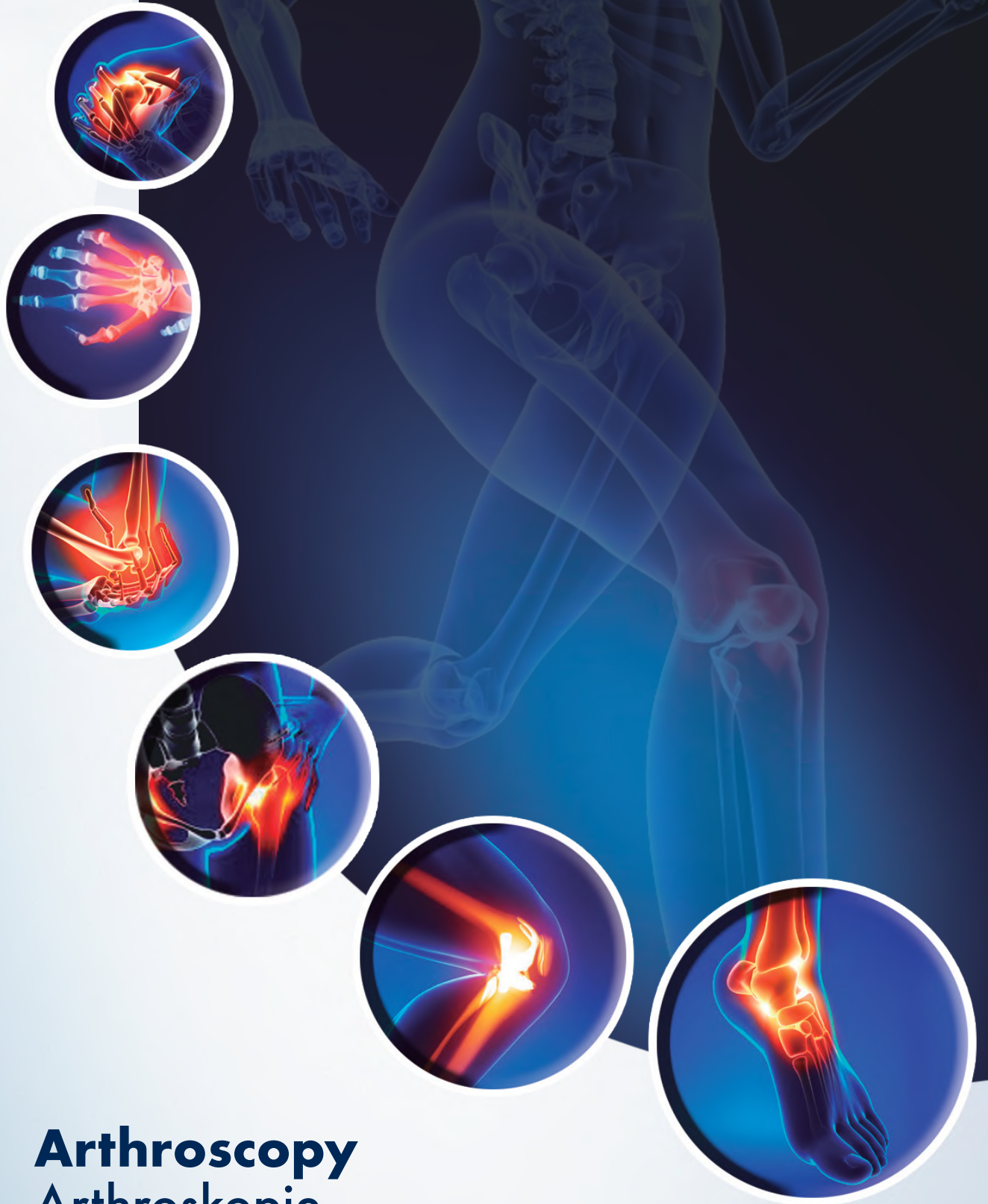

**Arthroscopy**  
Arthroskopie  
Artroscopia

**REMA Medizintechnik GmbH – a DEWIMED Company.**

**REMA was established more than 40 years ago and became a market leader for medical equipment, specializing in developing and manufacturing equipment for various medical disciplines in particular for minimal invasive interventions.**

**Our name is a trademark for high quality.**

**REMA products are sold in more than 70 countries world-wide. We are consistently expanding our portfolio in the areas of arthroscopy, laparoscopy, gynaecology and urology. Our products are manufactured in our own plants in Germany using the latest manufacturing technologies.**

**We consider our market-leading position as an obligation.**

**Our philosophy: Develop the most advanced surgical equipment. Manufacture according to the highest quality standards. Offer outstanding products at reasonable prices.**

REMA Medizintechnik GmbH – ein Unternehmen der DEWIMED Gruppe. Das Unternehmen REMA wurde vor mehr als 40 Jahren gegründet und entwickelte sich zum Marktführer für medizinische Instrumente. REMA spezialisierte sich auf die Entwicklung und Herstellung von Instrumenten für verschiedene medizinische Disziplinen, insbesondere für minimal-invasive Eingriffe.

Unser Name steht für höchste Qualität.

Vertreten in mehr als 70 Ländern weltweit, erweitert REMA konsequent sein Portfolio in den Bereichen Arthroskopie, Laparoskopie, Gynäkologie und Urologie.

Die Instrumente werden unter Anwendung modernster Fertigungstechnologien in eigenen Werkstätten in Deutschland hergestellt.

Unsere Position als Marktführer betrachten wir als Verpflichtung:

Unsere Zielsetzung ist die Entwicklung optimierter chirurgischer Instrumente für minimal-invasive Eingriffe und die Fertigung in höchster Qualität. REMA stellt seine Produkte dem Markt zu fairen Preisen zur Verfügung.

REMA Medizintechnik GmbH - una Compañía DEWIMED.

REMA se estableció hace más de 40 años y se convirtió en líder de mercado para equipos médicos, especializada en el desarrollo y fabricación de equipos para diversas disciplinas médicas, en particular para las intervenciones mínimamente invasivas.

Nuestro nombre es una marca comercial de alta calidad.

Los productos REMA se venden en más de 70 países de todo el mundo. Estamos ampliando constantemente nuestro portafolio de productos en las áreas de artroscopia, laparoscopia, ginecología y urología. Los productos son fabricados en nuestras propias instalaciones en Alemania, utilizando las últimas tecnologías de fabricación.

Consideramos nuestra posición de líder en el mercado como una obligación. Nuestra filosofía: desarrollar el equipo quirúrgico más avanzado. Fabricar de acuerdo a los más altos estándares de calidad. Ofrecer excelentes productos a precios justos.



**The REMA Arthroscopy catalog is splitted in chapters according to the different specialities. The REMA products are depicted the following way:**

**Der REMA athroskopiekatalog ist je nach fachdisziplin in kapitel unterteilt. Die REMA Produkte sind wie folgt dargestellt:**

**El catálogo de Artroscopia REMA está dividido en secciones de acuerdo a las especialidades. Los productos REMA se encuentran representados de la siguiente manera:**

**Product name**

- **Produktname**  
Nombre del producto

**Item number**

- **Artikelnummer**  
Números de artículo

**Sizes**

- **Maße**  
Medidas

**Instrument description**

- **Beschreibung instrument**  
Descripción del instrumento

- **Micro scissors**

- **14-00435**

- **130 mm, Ø 3,5 mm**

- **Micro scissors punch, straight**  
**Mikroschere, gerade**  
Micro tijera, recta



**• Neither the product images nor the technical drawing of this catalogue correspond to the real measure of the instruments.**

**• All instruments shown in this catalog are made of stainless steel.**

**• Die Produktabbildungen und technischen Zeichnungen entsprechen nicht dem tatsächlichen Maßstab!**

**• Alle instrumente sind aus Edelstahl.**

**• Las medidas de las imágenes y dibujos técnicos no corresponden al tamaño real de los instrumentos.**

**• Todos los instrumentos son de acero inoxidable.**

# INDEX

	<b>Page</b> Seite Página
<b>Knee and shoulder</b> Knie und Schulter Rodilla y hombro	7 - 62
<b>Small Joints</b> Kleingelenke Pequeñas articulaciones	63 - 78
<b>Shaver blades</b> Rotationsmesser und Fräser Cuchillas y fresas rotatorias	79 - 122
<b>Electrodes</b> Elektroden Electrodos	123 - 128
<b>Complements</b> Zubehör Complementos	129 - 132

---

---

---

---

---

---

---

---

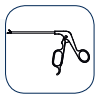

# Knee and shoulder

## Knie und Schulter

### Rodilla y hombro

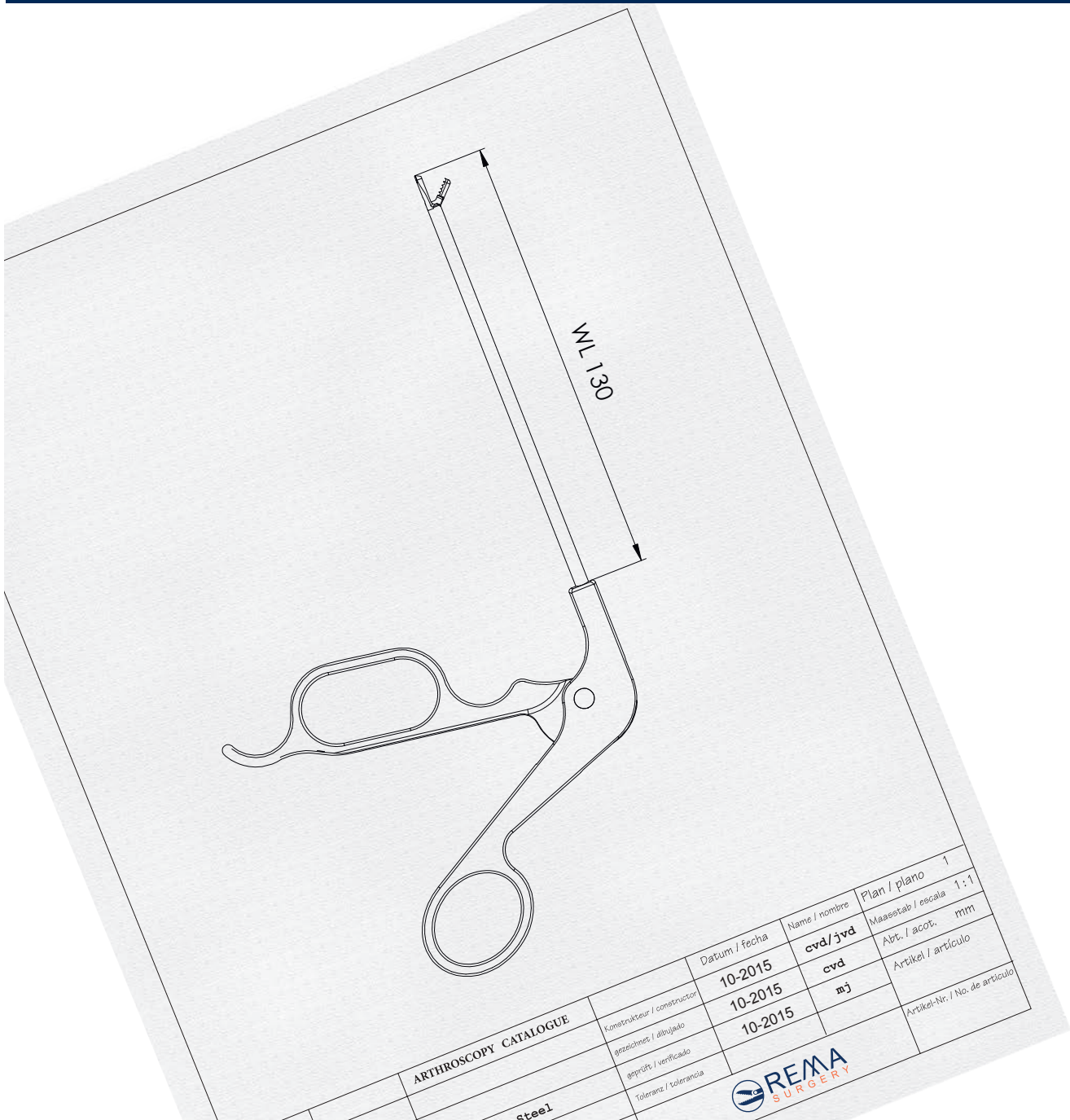



## Basic set for knee arthroscopy

### Basis-Set für Knie-Arthroskopie

Set básico para artroscopia de rodilla

#### Arthroscope

19-40013

175 mm, Ø 4,0 mm



#### Arthroscope view 30°

Arthroskop Blickrichtung 30°

Artroscopio 30°

#### Trocar sleeve

19-40212

175 mm, Ø 6 mm



#### Trocar sleeve with 2 rotatable stopcocks, suitable to optic Ø4,0 mm

Trokarhülsen mit 2 drehbaren Absperrhähnen, passend zu Optik Ø 4,0 mm

Vaina de trócar con 2 llaves giratorias, apto para sistema óptico de Ø 4,0 mm

#### Trocar pointed

19-40220

175 mm, Ø 4,2 mm



#### Trocar pointed, suitable to trocar sleeve Ø 6 mm

Trokar spitz, passend zu Trokarhülsen Ø 6 mm

Trócar puntiagudo para vaina de trócar Ø 6 mm

#### Trocar blunt

19-40221

175 mm, Ø 4,2 mm



#### Trocar blunt, suitable to trocar sleeve Ø 6 mm

Trokar stumpf, passend zu Trokarhülsen Ø 6 mm

Trocar romo para vaina de trócar Ø 6 mm

#### Fibre light cable

31-00151

2,3 m



#### Fibre light cable, REMA, STORZ

Fiberlichtkabel, REMA, STORZ

Cable de fibra óptica REMA, STORZ

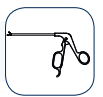

### Hook probe

17-09150

110 mm, Ø 5,0 mm



### Hook probe graduated

Hakensonde graduiert

Gancho palpador graduado

### Basket punch Duckbill

15-00211

130 mm

Ø3,2 cutting



### Basket punch Duckbill, straight, upbiter 15°

Korbstanze Duckbill Maulform gerade, Maul aufgebogen 15°

Pinza sacabocados de canasta, recta, con boca curvada 15° hacia arriba

### Basket punch Duckbill

15-00213

130 mm

Ø3,2 cutting



### Basket punch Duckbill, curved left 15°, upbiter 15°

Korbstanze Duckbill Maulform 15° links gebogen, Maul aufgebogen 15°

Pinza sacabocados de canasta, curvada 15° a la izquierda y boca curvada 15° hacia arriba

### Basket punch Duckbill

15-00214

130 mm

Ø 3,2 mm cutting



### Basket punch Duckbill, curved right 15°, upbiter 15°

Korbstanze Duckbill Maulform 15° rechts gebogen, Maul aufgebogen 15°

Pinza sacabocados de canasta, curvada 15° a la derecha y boca curvada 15° hacia arriba

### Basket punch Duckbill

15-00212

130 mm, Ø 3,5 mm

Ø 3,2 mm cutting



### Basket punch Duckbill, straight, upswept 15°

Korbstanze Duckbill Maulform im Schaft aufgebogen 15°

Pinza sacabocados de canasta, recta, con boca hacia arriba 15°

### Aluminium 3/4 container

85-212.100

465 x 280 x 100 mm

### Aluminium 3/4 container

Aluminium 3/4 Container

Contenedor 3/4 de aluminio



More information in REMASTERI catalog

## Treatment of cartilage defects - Microfracture

### Behandlung von Knorpeldefkten - Mikrofraktur

### Tratamiento para defectos de cartílago - Microfractura

#### Rasp

17-11140

110 m



#### Rasp straight

Raspel gerade

Escofina recta

#### Curette

17-03140

110 m

3,0 mm



#### Ring curette Ø 3,0 mm

Ring-Kürette, Ø 3,0 mm

Cureta circular, Ø 3,0 mm

#### Curette

17-03170

110 m

7,0 mm



#### Ring curette Ø 7,0 mm

Ring-Kürette, Ø 7,0 mm

Cureta circular, Ø 7,0 mm

#### Microfractor

15-18015

170 mm



#### Microfractor, 15° curved

Mikrofraktor, 15° gebogen

Microfracturador curvado 15°

#### Microfractor

15-18030

170 mm



#### Microfractor, 30° curved

Mikrofraktor, 30° gebogen

Microfracturador curvado 30°

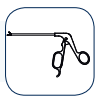

**Microfractor**

15-18045

170 mm



**Microfractor, 45° curved**

Mikrofraktor, 45° gebogen

Microfracturador curvado 45°

**Microfractor**

15-18090

170 mm



**Microfractor, 80° curved**

Mikrofraktor, 80° gebogen

Microfracturador curvado 80°

**Aluminium ¾ container**

85-212.100

465 x 280 x 100 mm



**Aluminium ¾ container**

Aluminium ¾ Container

Contenedor ¾ de aluminio

More information in REMASTERI catalog

## Basic set for shoulder arthroscopy

### Basis-Set für Schulter-Arthroskopie

Set básico para artroscopia de hombro

#### Arthroscope

19-40013

175 mm, Ø 4,0 mm



#### Arthroscope, view 30°

Arthroskop, Blickrichtung 30°

Artroscopio 30°

#### Trocar sleeve

19-40212

175 mm, Ø 6 mm



#### Trocar sleeve with 2 rotatable stopcocks, suitable to optic Ø 4,0 mm

Trokarhülsen mit 2 drehbaren Absperrhähnen, passend zu Optik Ø 4,0 mm

Vaina de trócar con 2 llaves giratorias, apto para sistema óptico de Ø 4,0 mm

#### Trocar pointed

19-40220

175 mm, Ø 4,2 mm



#### Trocar pointed, suitable to trocar sleeve Ø 6 mm

Trokar spitz, passend zu Trokarhülsen Ø 6 mm

Trócar puntiagudo para vaina de trócar Ø 6 mm

#### Trocar blunt

19-40221

175 mm, Ø 4,2 mm



#### Trocar blunt, suitable to trocar sleeve Ø 6 mm

Trokar stumpf, passend zu Trokarhülsen Ø 6 mm

Trócar romo para vaina de trócar Ø 6 mm

#### Fibre light cable

31-00151

2,3 m



#### Fiber light cable, REMA, STORZ

Fiberlichtkabel, REMA, STORZ

Cable de fibra óptica REMA, STORZ

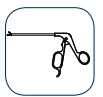

## Hook probe

17-09150

110 mm, Ø 5,0 mm



## Hook probe graduated

Hakensonde graduiert

Gancho palpador graduado

## Basket punch Duckbill

15-00211

130 mm, Ø 4,0 mm

 Ø3,2 mm cutting

## Basket punch Duckbill, straight, upbiter 15°

Korbstanze Duckbill Maulform gerade, Maul aufgebogen 15°

Pinza sacabocados de canasta, recta, con boca curvada 15° hacia arriba



## Basket punch Duckbill

15-00213

130 mm, Ø 4,0 mm

 Ø3,2 mm cutting

## Basket punch Duckbill, curved left 15°, upbiter 15°

Korbstanze Duckbill Maulform 15° links gebogen, Maul aufgebogen 15°

Pinza sacabocados de canasta, curvada 15° a la izquierda con boca curvada 15° hacia arriba



## Basket punch Duckbill

15-00214

130 mm, Ø 4,0 mm

 Ø3,2 mm cutting

## Basket punch Duckbill, curved right 15°, upbiter 15°

Korbstanze Duckbill Maulform 15° rechts gebogen, Maul aufgebogen 15°

Pinza sacabocados de canasta, curvada 15° a la derecha y boca curvada 15° hacia arriba



## Basket punch Duckbill

15-00212

130 mm, Ø 4,0 mm

 Ø3,2 mm cutting

## Basket punch Duckbill, straight, upswept 15°

Korbstanze Duckbill Maulform im Schaft aufgebogen 15°

Pinza sacabocados de canasta, recta, curvada 15° hacia arriba



## Basket punch

15-00221

130 mm, Ø 4,0 mm

 Ø 2,2 mm cutting

## Basket punch with hook, straight

Korbstanze mit Haken, gerade

Pinza sacabocados de canasta con boca en forma de gancho, recta



**Grasping forceps**

13-00035

130 mm, Ø 3,5 mm



**Grasping forceps**

Fasszange

Pinza de agarre

**Aluminium ¾ container**

85-212.100

465 x 280 x 100 mm



**Aluminium ¾ container**

Aluminium ¾ Container

Contenedor ¾ de aluminio

More information in REMASTERI catalog

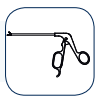

**Arthroscope**

Arthroskop  $\varnothing$  4 mm  
Artroscopio



HD

**Autoclavable**  
Autoklavierbar 134°C  
Autoclavable

**19-40010**

175 mm,  $\varnothing$  4,0 mm

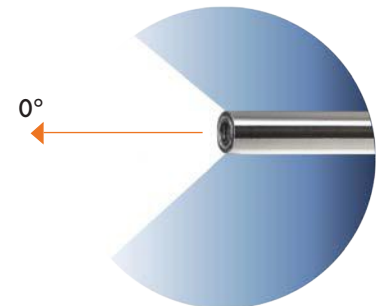

**Arthroscope, view 0°**

Arthroskop Blickrichtung 0°  
Artroscopio 0°

**19-40013**

175 mm,  $\varnothing$  4,0 mm

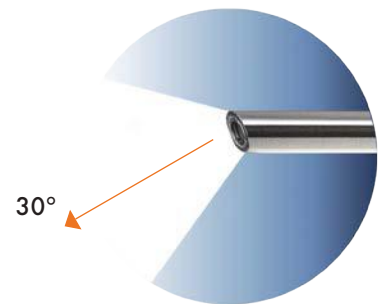

**Arthroscope, view 30°**

Arthroskop Blickrichtung 30°  
Artroscopio 30°

**19-40013**

175 mm,  $\varnothing$  4,0 mm

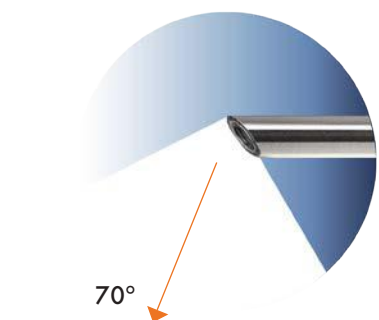

**Arthroscope, view 70°**

Arthroskop Blickrichtung 70°  
Artroscopio 70°



**Arthroscope**

Arthroskop Ø 2,7 mm

Artroscopio

**HD**



**Autoclavable**  
Autoklavierbar 134°C  
Autoclavable

**19-27000**

175 mm, Ø 2,7 mm

**Arthroscope, view 0°**

Arthroscope Blickrichtung 0°

Artroscopio 0°

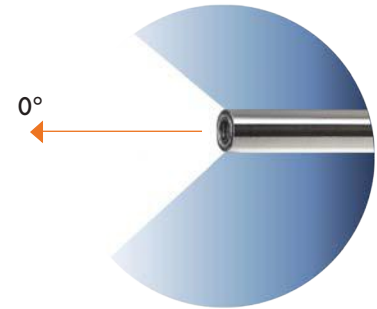

**19-27003**

175 mm, Ø 2,7 mm

**Arthroscope, view 30°**

Arthroscope Blickrichtung 30°

Artroscopio 30°

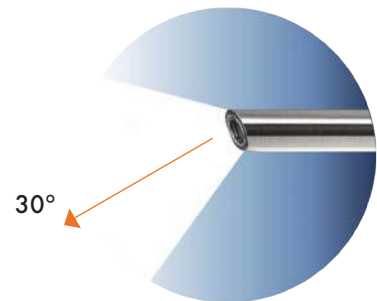

**19-27007**

175 mm, Ø 2,7 mm

**Arthroscope view 70°**

Arthroscope Blickrichtung 70°

Artroscopio 70°

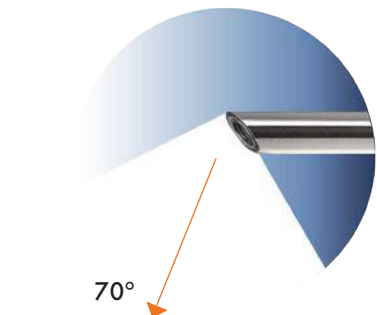

All optics are equipped with 3 different light guide connectors for the most common fibers.

Sämtliche Optiken sind mit 3-teiligem Lichtleiteranschluss für alle üblichen Lichtleitkabel ausgestattet.

Todos los sistemas ópticos están equipados con 3 conectores diferentes para los cables conductores de luz más comunes.

- ③ Storz®/Olympus®-Adapter
- ④ Wolf®/Adapter
- ⑤ ACMI® Anschluss / connector
- ⑥ Storz Anschluss / connector
- ⑦ Okulartrichter / Eye piece

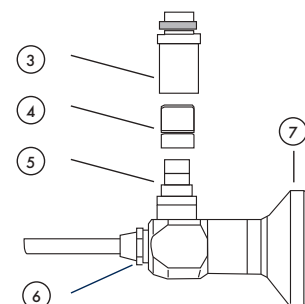



## Trocar sleeves and trocars

Trokarhülsen und Trokare  
Vainas de trocar y trócares

### Trocar sleeve

19-40212

175 mm, Ø 6 mm



### Trocar sleeve with 2 rotatable stopcocks, suitable to optic Ø 4,0 mm

Trokarhülsen mit 2 drehbaren Absperrhähnen, passend zu Optik Ø 4,0 mm

Vaina de trocar con 2 llaves giratorias, apto para sistema óptico de Ø 4,0 mm

### Trocar pointed

19-40220

175 mm, Ø 4,2 mm



### Trocar pointed, suitable to trocar sleeve Ø 6 mm

Trokar spitz, passend zu Trokarhülsen Ø 6 mm

Trócar puntiagudo para vaina de trocar de Ø 6 mm

### Trocar blunt

19-40221

175 mm, Ø 4,2 mm



### Trocar blunt, suitable to trocar sleeve Ø 6 mm

Trokar stumpf, passend zu Trokarhülsen Ø 6 mm

Trócar romo para vaina de trocar de Ø 6 mm

### Trocar sleeve

19-27212

175 mm, Ø 3,8 mm



### Trocar sleeve with 2 rotatable stopcocks, suitable to optic Ø 2,7 mm

Trokarhülsen mit 2 drehbaren Absperrhähnen, passend zu Optik Ø 2,7 mm

Vaina de trocar con 2 llaves giratorias, apto para sistema óptico de Ø 2,7 mm

### Trocar pointed

19-27220

175 mm, Ø 2,9 mm



### Trocar pointed, suitable to trocar sleeve Ø 3,8 mm

Trokar spitz, passend zu Trokarhülsen Ø 3,8 mm

Trócar puntiagudo para vaina de trocar Ø 3,8 mm

**Trocar blunt**

19-27221

175 mm, Ø 2,9 mm



**Trocar blunt, suitable to trocar sleeve Ø 3,8 mm**

Trokar stumpf, passend zu Trokarhülsen Ø 3,8 mm

Trocar romo para vaina de trócar Ø 3,8 mm

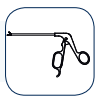

## Drainage cannulas Spül-Kanülen Cánulas de drenaje

### Drainage cannula

19-32000

70 mm, Ø 4,5 mm

Consists of:

#### Drainage cannula with Luer-lock

Spül-Kanüle mit Luer-lock

Cánula de drenaje con pieza Luer-lock



#### Trocar with oblique tip

Trokar spitz

Trócar con punta oblicua



#### Obturator

Trokar stumpf

Obturador



### Drainage Cannula

19-33000

70 mm, Ø 3,2 mm

Consists of:

#### Drainage cannula with Luer-lock

Spül-Kanüle mit Luer-lock

Cánula de drenaje con pieza Luer-lock



#### Trocar with oblique tip

Trokar spitz

Trócar con punta oblicua



#### Obturator

Trokar stumpf

Obturador



## Knee and shoulder instruments

### Knie und Schulter instrumente

Instrumentos para rodilla y hombro

#### Hook probes

##### Hakensonden

Gancho palpador

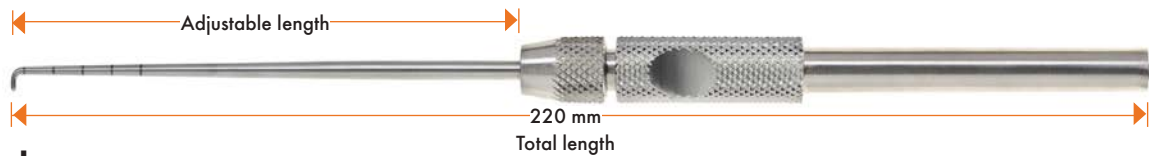

#### Handle only

19-00130

#### Hook probe

19-01125

220 mm, 2,5 mm



#### Hook probe graduated

Hakensonde graduert

Gancho palpador graduado

#### Hook probe

19-01135

220 mm, 3,5 mm



#### Hook probe graduated

Hakensonde graduert

Gancho palpador graduado

#### Hook probe

19-05130

220 mm



#### Hook probe pointed

Hakensonde spitz

Gancho palpador puntiagudo

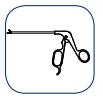

**Hook probe**

17-09140

110 mm, 3,0 mm



**Hook probe graduated**

Hakensonde graduert

Gancho palpador graduado

**Hook probe**

17-09150

220 mm, 5,0 mm



**Hook probe graduated**

Hakensonde graduert

Gancho palpador graduado

**Hook probe**

17-05130

220 mm

**Hook probe pointed**

Hakensonde spitz

Gancho palpador puntiagudo



**Curettes**

**Ring-Küretten**

Curetas



**Handle only**

19-00130

**Curette**

19-03130

220 mm, Ø 3,0 mm



**Ring curette**

Ring-Kürette

Cureta circular

**Curette**

19-03170

220 mm, Ø 7,0 mm



**Ring curette**

Ring-Kürette

Cureta circular



**Curette**

17-03140

110 mm, Ø 3,0 mm



**Ring curette**

Ring-Kürette

Cureta circular

**Curette**

17-03170

110 mm, Ø 7,0 mm



**Ring curette**

Ring-Kürette

Cureta circular

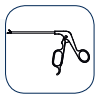

## Spoons

Löffeln

Cucharas

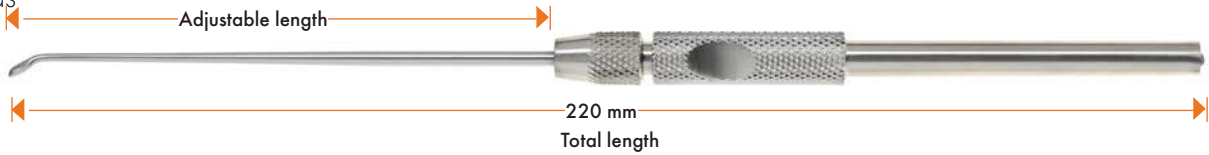

### Handle only

19-00130

## Spoon

19-08130

220 mm, Ø 3,0 mm



### Spoon curved 30°

Löffel gebogen 30°

Cuchara curvada 30°



## Spoon

17-08140

110 mm, Ø 3,0 mm



### Spoon curved 30°

Löffel gebogen 30°

Cuchara curvada 30°



**Meniscotomes**

**Meniskotome**

Meniscotomos

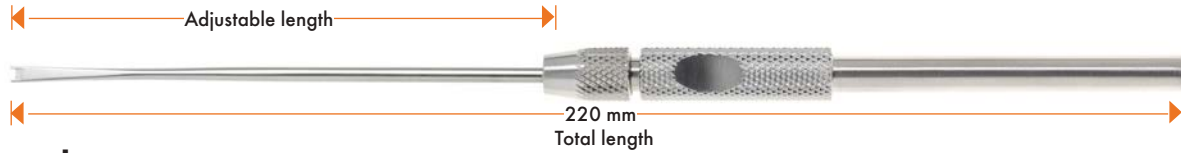

**Handle only**

19-00130

**Meniscotome**

19-06130

220 mm, 3,0 mm



**Meniscotome Smillie**

Meniskotom Smillie

Meniscotomo Smillie

**Meniscotome**

19-06150

220 mm, 5,0 mm



**Meniscotome Smillie**

Meniskotom Smillie

Meniscotomo Smillie

**Meniscotome**

19-06170

220 mm, 7,0 mm



**Meniscotome Smillie**

Meniskotom Smillie

Meniscotomo Smillie



**Meniscotome**

17-06140

110 mm, 3,0 mm



**Meniscotome Smillie**

Meniskotom Smillie

Meniscotomo Smillie

**Meniscotome**

17-02140

110 mm, 5,0 mm



**Meniscotome Smillie**

Meniskotom Smillie

Meniscotomo Smillie

**Meniscotome**

17-06170

110 mm, 7,0 mm



**Meniscotome Smillie**

Meniskotom Smillie

Meniscotomo Smillie

## Knives

Messer

Cuchillas

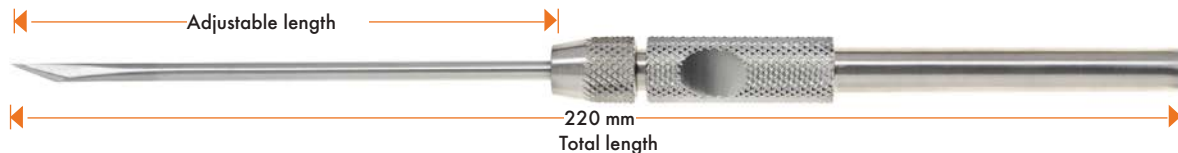

### Handle only

19-00130

## Bayonet knife

19-02130

220 mm



## Bayonet knife

Bajonettmesser

Cuchilla bayoneta

## Banana knife

19-10130

220 mm



## Bayonet knife smooth

Bananenmesser glatt

Cuchilla banana lisa

## Banana knife

19-12130

220 mm



## Banana knife toothed

Bananenmesser gezahnt

Cuchilla banana dentada

## Knife retrograde

19-11130

220 mm



## Knife 45° retrograde

Messer 45°, Gesamtlänge

Cuchilla retrograda 45°

## Scalpel knife

19-04130

220 mm



## Scalpel knife

Skalpelmesser

Escalpelo

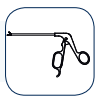

### Hook knife

19-09130

220 mm



### Hook knife 90°

Hakenmesser 90°

Cuchilla de gancho 90°

### Knife toothed

19-16130

220 mm



### Knife straight toothed

Messer gerade gezahnt

Cuchilla dentada recta

### Knife toothed, curved

19-17130

220 mm



### Knife toothed, curved left 30°

Messer gezahnt, gebogen links 30°

Cuchilla dentada, curvada 30° a la izquierda

### Knife toothed, curved

19-15130

220 mm



### Knife toothed, curved right 30°

Messer gezahnt, gebogen rechts 30°

Cuchilla dentada, curvada 30° a la derecha

### Sickle knife

19-13130

220 mm



### Sickle knife

Sichelmesser

Cuchilla hoz



**Bayonet knife**

17-02130

110 mm



**Bayonet knife**

Bajonettmesser

Cuchilla bayoneta

**Banana knife**

17-00140

110 mm



**Banana knife smooth**

Bananenmesser glatt

Cuchilla banana lisa

**Banana knife**

17-12140

110 mm



**Banana knife toothed**

Bananenmesser gezahnt

Cuchilla banana dentada

**Knife retrograde**

17-01140

110 mm



**Knife 45° retrograde**

Messer 45°, Gesamtlänge

Cuchilla retrograda 45°

**Scalpel knife**

17-04140

110 mm



**Scalpel knife**

Skalpelmesser

Escalpelo

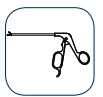

### Hook knife

17-05140

110 mm



### Hook knife 90°

Hakenmesser 90°

Cuchilla de gancho 90°

### Knife toothed

17-16140

110 mm



### knife, straight, toothed

Messer gerade gezahnt

Cuchilla dentada recta

### Knife toothed, curved

17-17130

110 mm



### Knife toothed, curved left 30°

Messer gezahnt, gebogen links 30°

Cuchilla dentada, curvada 30° a la izquierda

### Knife toothed, curved

17-15130

110 mm



### Knife toothed, curved right 30°

Messer gezahnt, gebogen rechts 30°

Cuchilla dentada, curvada 30° a la derecha

### Sickle knife

17-13130

110 mm



### Sickle knife

Sichelmesser

Cuchilla hoz

## Microfracture instruments

### Mikrofraktoren

Instrumentos para microfractura



---

### Microfractor

15-18000

170 mm, 0°



### Microfractor 0°

Mikrofraktor, 0°

Microfracturador 0°

---

### Microfractor

15-18015

170 mm, 15°



### Microfractor 15° curved

Mikrofraktor, 15° gebogen

Microfracturador curvado 15°

---

### Microfractor

15-18030

170 mm, 30°



### Microfractor 30° curved

Mikrofraktor, 30° gebogen

Microfracturador curvado 30°

---

### Microfractor

15-18045

170 mm, 45°



### Microfractor 45° curved

Mikrofraktor, 45° gebogen

Microfracturador curvado 45°

---

### Microfractor

15-18090

170 mm, 80°



### Microfractor 80° curved

Mikrofraktor, 80° gebogen

Microfracturador curvado 80°



**Rasp**  
Raspeln  
Escofinas



**Rasp**  
17-11140  
125 mm

**Rasp straight**  
Raspel gerade  
Escofina recta





## EXCALIBUR punches

### EXCALIBUR Stanzen

Pinzas sacabocados EXCALIBUR

#### Basket punches Duckbill

Korbstanzen Duckbill Maulform

Pinzas sacabocados de canasta



#### Basket punch Duckbill

15-00210

130 mm, Ø 4 mm

Ø3,2 mm cutting



W 3,5 mm  
H 2,2 mm  
L 5 mm

#### Basket punch Duckbill, straight

Korbstanze Duckbill Maulform, gerade

Pinza sacabocados de canasta, recta

#### Basket punch Duckbill

15-00211

130 mm, Ø 4 mm

Ø3,2 mm cutting



#### Basket punch Duckbill, straight, upbiter 15°

Korbstanze Duckbill Maulform gerade, Maul aufgebogen 15°

Pinza sacabocados de canasta, recta, con boca curvada 15° hacia arriba

W 3,5 mm  
H 2,2 mm  
L 5 mm

#### Basket punch Duckbill

15-00212

130 mm, Ø 4 mm

Ø3,2 mm cutting



#### Basket punch Duckbill, straight, upswept 15°

Korbstanze Duckbill Maulform im Schaft aufgebogen 15°

Pinza sacabocados de canasta, recta, con boca hacia arriba 15°

W 3,5 mm  
H 2,2 mm  
L 5 mm

#### Basket punch Duckbill

15-00213

130 mm, Ø 4 mm

Ø3,2 mm cutting



#### Basket punch Duckbill, curved left 15°, upbiter 15°

Korbstanze Duckbill Maulform 15° links gebogen, Maul aufgebogen 15°

Pinza sacabocados de canasta, curvada 15° a la izquierda y boca curvada 15° hacia arriba

W 3,5 mm  
H 2,2 mm  
L 5 mm

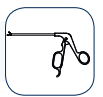

### Basket punch Duckbill

15-00214

130 mm, Ø 4 mm

 Ø3,2 mm cutting



### Basket punch Duckbill, curved right 15°, upbiter 15°

Korbstanze Duckbill Maulform 15° rechts gebogen, Maul aufgebogen 15°

Pinza sacabocados de canasta, curvada 15° a la derecha y boca curvada 15° hacia arriba

W 3,5 mm

H 2,2 mm

L 5 mm

### Basket punch Duckbill

15-00234

130 mm, Ø 4 mm

 Ø3,2 mm cutting



### Basket punch Duckbill, straight, curved right

Korbstanze Duckbill Maulform gerade, rechts gebogen

Pinza sacabocados de canasta, recta, curvada a la derecha

W 3,5 mm

H 2,2 mm

L 5 mm

### Basket punch Duckbill

15-00233

130 mm, Ø 4 mm

 Ø3,2 mm cutting



### Basket punch Duckbill, straight, curved left

Korbstanze Duckbill Maulform gerade, links gebogen

Pinza sacabocados de canasta, recta, curvada a la izquierda

W 3,5 mm

H 2,2 mm

L 5 mm

## Basket punches oval

### Korbstanze oval

Pinza sacabocados ovalada

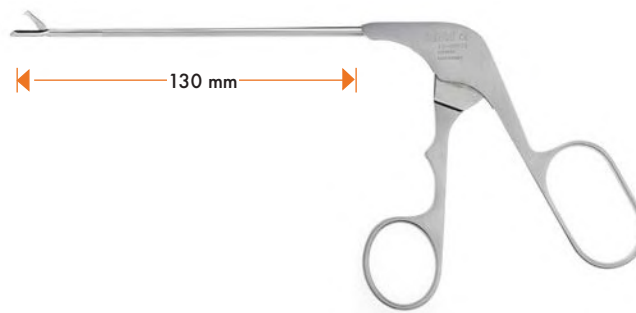

## Basket punches oval

15-00215

130 mm, Ø 4 mm

● Ø4,4 mm cutting



## Basket punch oval, straight

### Korbstanze oval, gerade

Pinza sacabocados ovalada de canasta, recta

W 4 mm  
H 2,2 mm  
L 5 mm

## Basket punches oval

15-00218

130 mm, Ø 4 mm

● Ø4,4 mm cutting



## Basket punch oval, straight, upswept 15°

### Korbstanze oval Maulform im Schaft aufgebogen 15°

Pinza sacabocados ovalada de canasta, recta, curvada 15° hacia arriba

W 4 mm  
H 2,2 mm  
L 5 mm

## Basket punches oval

15-00216

130 mm, Ø 4 mm

● Ø4,4 mm cutting



## Basket punch oval, straight, curved right

### Korbstanze oval Maulform gerade, rechts gebogen

Pinza sacabocados ovalada de canasta, recta, curvada a la derecha

W 4 mm  
H 2,2 mm  
L 5 mm

## Basket punches oval

15-00217

130 mm, Ø 4 mm

● Ø4,4 mm cutting



## Basket punch oval, straight, curved left

### Korbstanze oval, Maulform gerade, links gebogen

Pinza sacabocados de canasta ovalada, recta, curvada a la izquierda

W 4 mm  
H 2,2 mm  
L 5 mm

## Basket punches oval

15-00219

130 mm, Ø 4 mm

● Ø4,4 mm cutting



## Basket punch oval, straight, upbiter 15°

### Korbstanze oval, gerade, Maul aufgebogen 15°

Pinza sacabocados de canasta ovalada, recta, con boca curvada hacia arriba 15°

W 4 mm  
H 2,2 mm  
L 5 mm

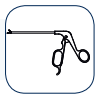

## Basket punches with hook

### Korbstanzen mit Haken

Pinzas sacabocados de gancho



## Basket punch

15-00221

130 mm, Ø 4 mm

 Ø2,2 mm cutting

## Basket punch with hook, straight

### Korbstanze mit Haken, gerade

Pinza sacabocados de canasta con boca en forma de gancho, recta



W 2 mm

H 3 mm

L 6 mm

## Basket punch

15-00220

130 mm, Ø 4 mm

 Ø1,6 mm cutting

## Basket punch with hook, straight

### Korbstanze mit Haken, gerade

Pinza sacabocados de canasta con boca en forma de gancho, recta



W 1,5 mm

H 2 mm

L 5 mm

**Grasping forceps**

Fasszangen

Pinzas de agarre



**Grasping forceps pitbull jaw**

15-00295

130 mm, Ø 4 mm

**Grasping forceps, straight, pitbull jaw**

Fasszange gerade, Pitbull Maulteil

Pinza de agarre recta, boca pitbull



**Grasping forceps alligator jaw**

15-00290

130 mm, Ø 4 mm

**Grasping forceps, straight, alligator jaw**

Fasszange gerade, Alligator Maulteil

Pinza de agarre recta, boca alligator



**Grasping forceps with locking mechanism**

Fasszangen mit Sperre

Pinzas de agarre con mecanismo de bloqueo



**Grasping forceps pitbull jaw**

15-00296

130 mm, Ø 4 mm

**Grasping forceps, straight, pitbull jaw, with locking mechanism**

Fasszange gerade, Pitbull Maulteil mit Sperre

Pinza de agarre recta con boca pitbull y mecanismo de bloqueo



**Grasping forceps alligator jaw**

15-00291

130 mm, Ø 4 mm

**Grasping forceps, straight, alligator jaw, with locking mechanism**

Fasszange gerade, Alligator Maulteil mit Sperre

Pinza de agarre recta con boca alligator y mecanismo de bloqueo



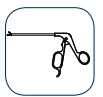

## Suture grasping forceps with protective device and flushing canal Fadenfazzangen mit Überlastungsschutz und Spülkanal Pinzas de agarre para sutura con dispositivo de protección y canal de flujo

Ordering example: Suture grasping forceps, straight, with handle RA-S -> Item number 11-10135-RA-S

Bestellbeispiel: Fadenfazzange, gerade, mit Griff RA-S -> Artikelnummer 11-10135-RA-S

Ejemplo de pedido: Pinza de agarre para sutura, recta, con mango RA-S -> número de artículo 11-10135-RA-S

### Handle

xx-xxxxx-RA-S

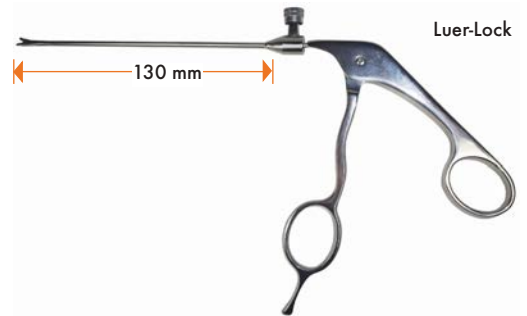

### Handle with protective device, flushing canal and Luer-Lock

Handgriff mit Überlastungsschutz, Spülkanal und Luer-Lock

Mango con dispositivo de protección, canal de flujo y Luer-Lock

### Handle

xx-xxxxx-RB-S

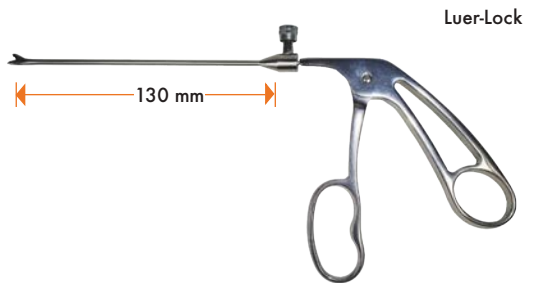

### Handle with protective device, flushing canal and Luer-Lock

Handgriff mit Überlastungsschutz, Spülkanal und Luer-Lock

Mango con dispositivo de protección, canal de flujo y Luer-Lock

### Suture grasping forceps

11-10135-xx-x

130 mm, Ø 3,5 mm



### Suture grasping forceps, straight

Fadenfazzange gerade

Pinza de agarre para sutura, recta, atraumática

### Suture grasping forceps

11-10235-xx-x

130 mm, Ø 3,5 mm



### Suture grasping forceps, 45° sharp up milled

Fadenfazzange 45°, scharf, aufwärts gefräst

Pinza de agarre para sutura, curvada 45° hacia arriba

### Suture grasping forceps

11-10335-xx-x

130 mm, Ø 3,5 mm



### Suture grasping forceps, sharp, straight

Fadenfazzange, scharf, gerade

Pinza de agarre para sutura, recta, con punta traumática

## Wide jaw punches with protective device and flushing canal Breitmaulstanzen mit Überlastungsschutz und Spülkanal Pinzas sacabocados con dispositivo de protección y canal de flujo

Ordering example: Suture grasping forceps, straight, with handle RA-S -> Item number 11-10135-RA-S

Bestellbeispiel: Fadenfazzange, gerade, mit Griff RA-S -> Artikelnummer 11-10135-RA-S

Ejemplo de pedido: Pinza de agarre para sutura, recta, con mango RA-S -> número de artículo 11-10135-RA-S

### Handle

xx-xxxxx-RA-S

### Handle with protective device, flushing canal and Luer-Lock Estilo de fuente no es correcta

Mango con dispositivo de protección, canal de flujo y Luer-Lock

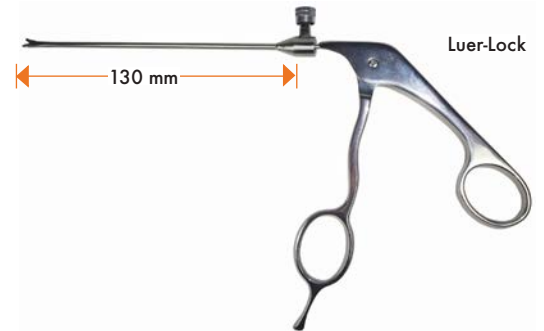

### Handle

xx-xxxxx-RB-S

### Handle with protective device, flushing canal and Luer-Lock

Handgriff mit Überlastungsschutz, Spülkanal und Luer-Lock

Mango con dispositivo de protección, canal de flujo y Luer-Lock



### Straight punch

11-00335-xx-x

130 mm, Ø 3,5 mm



### Wide jaw punch, straight, large

Breitmaulstanzen, gerade, groß

Pinza sacabocados recta, grande

5,0 x 4,5 mm

### Straight punch

11-20335-xx-x

130 mm, Ø 3,5 mm

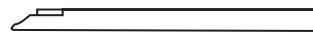

### Wide jaw punch, straight, medium

Breitmaulstanzen, gerade, medium

Pinza sacabocados recta, mediana

5,0 x 3,5 mm

### Straight punch

11-40335-xx-x

130 mm, Ø 3,5 mm



### Wide jaw punch straight, small

Breitmaulstanzen, gerade, klein

Pinza sacabocados recta, pequeña

6,0 x 2,5 mm

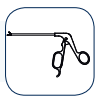

### Curved punch

11-01335-xx-x

130 mm, Ø 3,5 mm



### Wide jaw punch curved 30° right, large

Breitmaulstanzen gebogen 30° rechts, groß

Pinza sacabocados curvada 30° a la derecha, grande

5,0 x 4,5 mm

### Curved punch

11-21335-xx-x

130 mm, Ø 3,5 mm



### Wide jaw punch curved 30° right, medium

Breitmaulstanzen gebogen 30° rechts, medium

Pinza sacabocados curvada 30° a la derecha, mediana

5,0 x 3,5 mm

### Curved punch

11-41335-xx-x

130 mm, Ø 3,5 mm



### Wide jaw punch curved 30° right, small

Breitmaulstanzen gebogen 30° rechts, klein

Pinza sacabocados curvada 30° a la derecha, pequeña

6,0 x 2,5 mm

### Curved punch

11-03335-xx-x

130 mm, Ø 3,5 mm

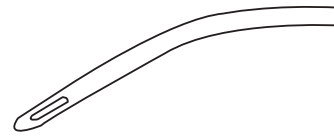

### Wide jaw punch curved 30° left, large

Breitmaulstanzen gebogen 30° links, groß

Pinza sacabocados curvada 30° a la izquierda, grande

5,0 x 4,5 mm

### Curved punch

11-23335-xx-x

130 mm, Ø 3,5 mm

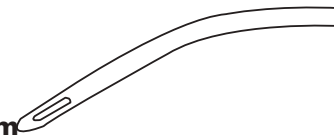

### Wide jaw punch curved 30° left, medium

Breitmaulstanzen gebogen 30° links, medium

Pinza sacabocados curvada 30° a la izquierda, mediana

5,0 x 3,5 mm

### Curved punch

11-43335-xx-x

130 mm, Ø 3,5 mm



### Wide jaw punch curved 30° left, small

Breitmaulstanzen gebogen 30° links, klein

Pinza sacabocados curvada 30° a la izquierda, pequeña

6,0 x 2,5 mm



### Curved punch

11-13335-xx-x

130 mm, Ø 3,5 mm



### Wide jaw punch curved 15° upward, large

Breitmaulstanzen gebogen 15° aufwärts, groß

Pinza sacabocados curvada 15° hacia arriba, grande

5,0 x 4,5 mm

### Curved punch

11-33335-xx-x

130 mm, Ø 3,5 mm



### Wide jaw punch curved 15° upward, medium

Breitmaulstanzen gebogen 15° aufwärts, medium

Pinza sacabocados curvada 15° hacia arriba, mediana

5,0 x 3,5 mm

### Curved punch

11-53335-xx-x

130 mm, Ø 3,5 mm



### Wide jaw punch curved 15° upward, small

Breitmaulstanzen 15° aufwärts, klein

Pinza sacabocados curvada 15° hacia arriba, pequeña

6,0 x 2,5 mm

### Curved basket punch

11-60335-xx-x

130 mm, Ø 3,5 mm

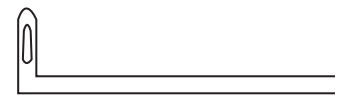

### Basket punch, curved 90° right, medium

Korbstanze, gebogen 90° rechts, medium

Pinza sacabocados de canasta curvada 90° hacia la derecha, mediana

5,0 x 3,0 mm

### Curved basket punch

11-64335-xx-x

130 mm, Ø 3,5 mm



### Basket punch, curved 90° right, small

Korbstanze gebogen 90° rechts, klein

Pinza sacabocados de canasta curvada 90° hacia la derecha, pequeña

5,0 x 1,8 mm

### Curved basket punch

11-62335-xx-x

130 mm, Ø 3,5 mm

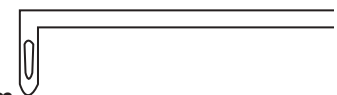

### Basket punch curved 90° left, medium

Korbstanze gebogen 90° links, medium

Pinza sacabocados de canasta curvada 90° hacia la izquierda, mediana

7,0 x 3,0 mm



### Curved basket punch

11-66335-xx-x

130 mm, Ø 3,5 mm

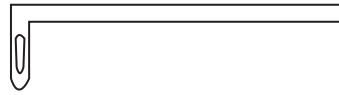

### Basket punch curved 90° left, small

Korbstanze gebogen 90° links, klein

Pinza sacabocados de canasta curvada 90° hacia la izquierda, pequeña

7,0 x 1,8 mm

## Wide jaw punches with protective device

Breitmaulstanzen mit Überlastungsschutz

Pinzas sacabocados con dispositivo de protección



### Straight punch

14-00335

130 mm, Ø 3,5 mm

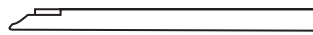

### Wide jaw punch, straight, large

Breitmaulstanzen, gerade, groß

Pinza sacabocados recta, grande

5,0 x 4,5 mm

### Straight punch

14-20335

130 mm, Ø 3,5 mm

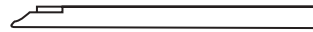

### Wide jaw punch, straight, medium

Breitmaulstanzen, gerade, medium

Pinza sacabocados recta, mediana

5,0 x 3,5 mm

### Straight punch

14-40335

130 mm, Ø 3,5 mm

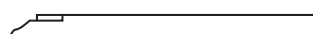

### Wide jaw punch, straight, small

Breitmaulstanzen, gerade, klein

Pinza sacabocados recta, pequeña

6,0 x 2,5 mm

**Curved punch**

14-01335

130 mm, Ø 3,5 mm



**Wide jaw punch curved 30° right, large**

Breitmaulstanzen gebogen 30° rechts, groß

Pinza sacabocados curvada 30° a la derecha, grande

5,0 x 4,5 mm

**Curved punch**

14-21335

130 mm, Ø 3,5 mm



**Wide jaw punch curved 30° right, medium**

Breitmaulstanzen gebogen 30° rechts, medium

Pinza sacabocados curvada 30° a la derecha, mediana

5,0 x 3,5 mm

**Curved punch**

14-41335

130 mm, Ø 3,5 mm



**Wide jaw punch curved 30° right, small**

Breitmaulstanzen gebogen 30° rechts, klein

Pinza sacabocados curvada 30° a la derecha, pequeña

6,0 x 2,5 mm

**Curved punch**

14-03335

130 mm, Ø 3,5 mm



**Wide jaw punch curved 30° left, large**

Breitmaulstanzen gebogen 30° links, groß

Pinza sacabocados curvada 30° a la izquierda, grande

5,0 x 4,5 mm

**Curved punch**

14-23335

130 mm, Ø 3,5 mm



**Wide jaw punch curved 30° left, medium**

Breitmaulstanzen gebogen 30° links, medium

Pinza sacabocados curvada 30° a la izquierda, mediana

5,0 x 3,5 mm

**Curved punch**

14-43335

130 mm, Ø 3,5 mm



**Wide jaw punch curved 30° left, small**

Breitmaulstanzen gebogen 30° links, klein

Pinza sacabocados curvada 30° a la izquierda, pequeña

6,0 x 2,5 mm

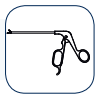

### Curved punch

14-13335

130 mm, Ø 3,5 mm



### Wide jaw punch curved 15° upward, large

Breitmaulstanzen gebogen 15° aufwärts, groß

Pinza sacabocados curvada 15° hacia arriba, grande

5,0 x 4,5 mm

### Curved punch

14-13335

130 mm, Ø 3,5 mm



### Wide jaw punch curved 15° upward, medium

Breitmaulstanzen gebogen 15° aufwärts, medium

Pinza sacabocados curvada 15° hacia arriba, mediana

5,0 x 3,5 mm

### Curved punch

14-33335

130 mm, Ø 3,5 mm



### Wide jaw punch curved 15° upward, small

Breitmaulstanzen 15° aufwärts, klein

Pinza sacabocados curvada 15° hacia arriba, pequeña

6,0 x 2,5 mm

### Curved basket punch

14-60335

130 mm, Ø 3,5 mm



### Basket punch, curved 90° right, medium

Korbstanze, gebogen 90° rechts, medium

Pinza sacabocados tipo canasta curvada 90° hacia la derecha, mediana

7,0 x 3,0 mm

### Curved basket punch

14-64335

130 mm, Ø 3,5 mm



### Basket punch, curved 90° right, small

Korbstanze gebogen 90° rechts, klein

Pinza sacabocados tipo canasta curvada 90° hacia la derecha, pequeña

7,0 x 1,8 mm

### Curved basket punch

14-62335

130 mm, Ø 3,5 mm



### Basket punch curved 90° left, medium

Korbstanze gebogen 90° links, medium

Pinza sacabocados tipo canasta curvada 90° hacia la izquierda, mediana

7,0 x 3,0 mm

### Curved basket punch

11-66335

130 mm, Ø 3,5 mm

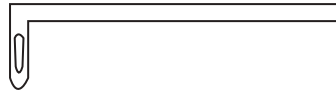

### Basket punch curved 90° left, small

Korbstanze gebogen 90° links, klein

Pinza sacabocados tipo canasta curvada 90° hacia la izquierda, pequeña

7,0 x 1,8 mm

## Hook punches with protective device

Hakenstanzen mit Überlastungsschutz

Pinzas de gancho con dispositivo de protección

### Hook punches

Hakenstanzen

Pinzas de gancho



### Straight hook punch

13-00335

130 mm, Ø 3,5 mm



### Hook punch, straight with scoop

Hakenstanze, gerade mit Schaufel

Pinza sacabocados de gancho, recta con pala

### Straight hook punch

13-20335

130 mm, Ø 3,5 mm

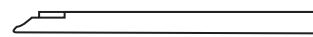

### Hook punch, straight, blunt

Hakenstanze, gerade, stumpf

Pinza sacabocados de gancho, recta, romo

### Straight hook punch

13-40335

130 mm, Ø 3,5 mm

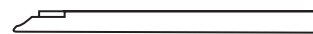

### Hook punch, straight, flat

Hakenstanze, gerade, flach

Pinza sacabocados de gancho, recta, plana

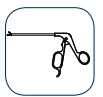

### Curved hook punch

13-01335

130 mm, Ø 3,5 mm



### Hook punch curved 30° right, with scoop

Hakenstanze gebogen 30° rechts mit Schaufel

Pinza sacabocados de gancho, curvada 30° a la derecha con pala

### Curved hook punch

13-21335

130 mm, Ø 3,5 mm



### Hook punch curved 30° right, blunt

Hakenstanze gebogen 30° rechts, stumpf

Pinza sacabocados de gancho, curvada 30° a la derecha, romo

### Curved hook punch

13-41335

130 mm, Ø 3,5 mm



### Hook punch curved 30° right, flat

Hakenstanze gebogen 30° rechts, flach

Pinza sacabocados de gancho, curvada 30° a la derecha, plana

### Curved hook punch

13-03335

130 mm, Ø 3,5 mm



### Hook punch curved 30° left, with scoop

Hakenstanze gebogen 30° links, mit Schaufel

Pinza sacabocados, boca en forma de gancho, curvada 30° hacia la izquierda y pala

### Curved hook punch

13-23335

130 mm, Ø 3,5 mm



### Hook punch curved 30° left, blunt

Hakenstanze gebogen 30° links, stumpf

Pinza sacabocados de gancho, curvada 30° a la izquierda con pala

### Curved hook punch

13-43335

130 mm, Ø 3,5 mm



### Hook punch curved 30° left, flat

Hakenstanze gebogen 30° links, flach

Pinza sacabocados de gancho, curvada 30° a la izquierda, plana

**Curved hook punch**

13-05335  
130 mm, Ø 3,5

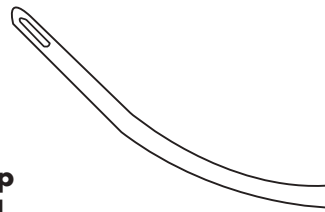

**Hook punch curved 45° right, with scoop**

Hakenstanze gebogen 45° rechts, mit Schaufel

Pinza sacabocados de gancho, curvada 45° a la derecha con pala

**Curved hook punch**

13-25335  
130 mm, Ø 3,5

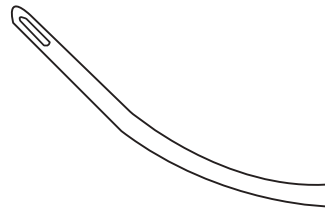

**Hook punch curved 45° right, blunt**

Hakenstanze gebogen 45° rechts, stumpf

Pinza sacabocados de gancho, curvada 45° a la derecha, romo

**Curved hook punch**

13-45335  
130 mm, Ø 3,5

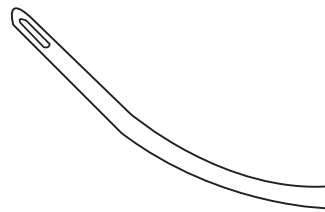

**Hook punch curved 45° right, flat**

Hakenstanze, gebogen 45° rechts, flach

Pinza sacabocados de gancho, curvada 45° a la derecha, plana

**Curved hook punch**

13-07335  
130 mm, Ø 3,5

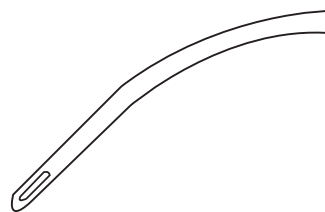

**Hook punch curved 45° left, with scoop**

Hakenstanze gebogen 45° links, mit Schaufel

Pinza sacabocados de gancho, curvada 45° a la izquierda con pala

**Curved hook punch**

13-27335  
130 mm, Ø 3,5

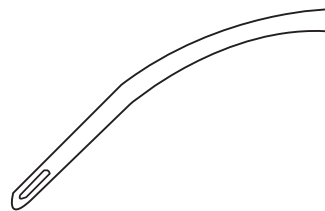

**Hook punch curved 45° left, blunt**

Hakenstanze gebogen 45° links, stumpf

Pinza sacabocados de gancho, curvada 45° a la izquierda, romo

**Curved hook punch**

13-47335  
130 mm, Ø 3,5

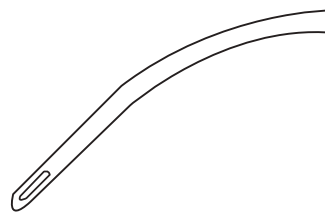

**Hook punch curved 45° left, flat**

Hakenstanze gebogen 45° links, flach

Pinza sacabocados de gancho, curvada 45° a la izquierda, plana

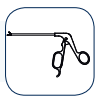

## Curved hook punch

13-09335

130 mm, Ø 3,5 mm



## Hook punch curved 7° upward, with scoop

Hakenstanze 7° aufwärts, mit Schaufel

Pinza sacabocados de gancho, curvada 7° hacia arriba con pala

## Curved hook punch

13-29335

130 mm, Ø 3,5 mm



## Hook punch curved 7° upward, blunt

Hakenstanze gebogen 7° aufwärts, stumpf

Pinza sacabocados de gancho, curvada 7° hacia arriba, romo

## Curved hook punch

13-49335

130 mm, Ø 3,5 mm



## Hook punch curved 7° upward, flat

Hakenstanze gebogen 7° aufwärts, flach

Pinza sacabocados de gancho, curvada 7° hacia arriba, plana

## Curved hook punch

13-11335

130 mm, Ø 3,5 mm



## Hook punch curved 7° downward with scoop

Hakenstanze gebogen 7° abwärts, mit Schaufel

Pinza sacabocados de gancho, curvada 7° hacia abajo con pala

## Curved hook punch

13-31335

130 mm, Ø 3,5

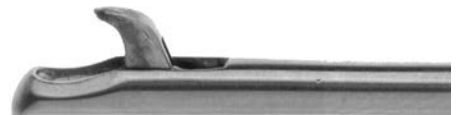

## Hook punch curved 7° downward, blunt

Hakenstanze gebogen 7° abwärts, stumpf

Pinza sacabocados de gancho, curvada 7° hacia abajo, romo

## Curved hook punch

13-51335

130 mm, Ø 3,5 mm



## Hook punch curved 7° downward, flat

Hakenstanze gebogen 7° abwärts, flach

Pinza sacabocados de gancho, curvada 7° hacia abajo, plana



## Curved hook punch

13-13335

130 mm, Ø 3,5 mm



### Hook punch curved 15° upward with scoop

Hakenstanze gebogen 15° aufwärts, mit Schaufel

Pinza sacabocados de gancho, curvada 15° hacia arriba con pala

## Curved hook punch

13-33335

130 mm, Ø 3,5 mm



### Hook punch curved 15° upward, blunt

Hakenstanze gebogen 15° aufwärts, stumpf

Pinza sacabocados de gancho, curvada 15° hacia arriba, romo

## Curved hook punch

13-53335

130 mm, Ø 3,5 mm



### Hook punch curved 15° upward, flat

Hakenstanze gebogen 15° aufwärts, flach

Pinza sacabocados de gancho, curvada 15° hacia arriba, plana

## Curved hook punch

13-15335

130 mm, Ø 3,5 mm



### Hook punch curved 15° downward with scoop

Hakenstanze gebogen 15° abwärts, mit Schaufel

Pinza sacabocados de gancho, curvada 15° hacia abajo con pala

## Curved hook punch

13-35335

130 mm, Ø 3,5 mm



### Hook punch curved 15° downward, blunt

Hakenstanze gebogen 15° abwärts, stumpf

Pinza sacabocados de gancho, curvada 15° hacia abajo, romo

## Curved hook punch

13-55335

130 mm, Ø 3,5 mm



### Hook punch curved 15° downward, flat

Hakenstanze gebogen 15° abwärts, flach

Pinza sacabocados de gancho, curvada 15° hacia abajo, plana



## Hook scissors with protective device Hakenscheren mit Überlastungsschutz Tijeras de gancho con dispositivo de protección

**Hook scissors**  
Hakenscheren  
Tijeras de gancho



**Straight hook scissors**

13-00435  
130 mm, Ø 3,5 mm

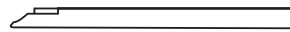

**Hook scissors, straight**  
Hakenschere, gerade  
Tijera de gancho, recta

**Curved hook scissors**

13-01435  
130 mm, Ø 3,5 mm

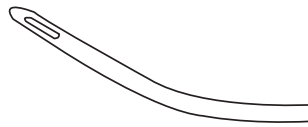

**Hook scissors, curved 30° right**  
Hakenschere, gebogen 30° rechts  
Tijera de gancho, curvada 30° a la derecha

**Curved hook scissors**

13-03435  
130 mm, Ø 3,5 mm

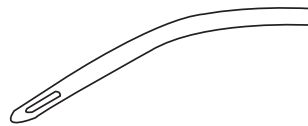

**Hook scissors, curved 30° left**  
Hakenschere, gebogen 30° links  
Tijera de gancho, curvada 30° a la izquierda

**Curved hook scissors**

13-05435  
130 mm, Ø 3,5 mm

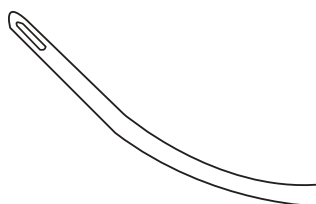

**Hook scissors, curved 45° right**  
Hakenschere, gebogen 45° rechts  
Tijera de gancho, curvada 45° a la derecha

**Curved hook scissors**

13-07435

130 mm, Ø 3,5 mm

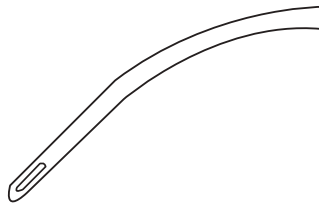

**Hook scissors, curved 45° left**

Hakenschere, gebogen 45° links

Tijera de gancho, curvada 45° a la izquierda

**Curved hook scissors**

13-09435

130 mm, Ø 3,5 mm



**Hook scissors, curved 7° upward**

Hakenschere, gebogen 7° aufwärts

Tijera de gancho, curvada 7° hacia arriba

**Curved hook scissors**

13-11435

130 mm, Ø 3,5 mm



**Hook scissors, curved 7° downward**

Hakenschere, gebogen 7° abwärts

Tijera de gancho, curvada 7° hacia abajo

**Curved hook scissors**

13-13435

130mm, Ø 3,5 mm



**Hook scissors, curved 15° upward**

Hakenschere, gebogen 15° aufwärts

Tijera de gancho, curvada 15° hacia arriba

**Curved hook scissors**

13-15435

130 mm, Ø 3,5 mm



**Hook scissors, curved 15° downward**

Hakenschere, gebogen 15° abwärts

Tijera de gancho, curvada 15° hacia abajo

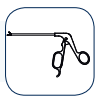

## Grasping and biopsy forceps with protective device

Fass- und PE-Zangen mit Überlastungsschutz

Pinzas de agarre y biopsia con dispositivo de protección

### Grasping and biopsy forceps

Fass- und PE-Zangen

Pinzas de agarre y biopsia

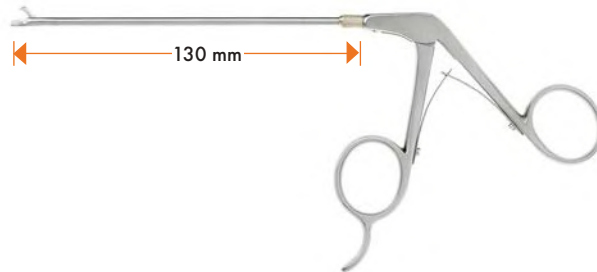

### Grasping forceps

13-00035

130 mm, Ø 3,5 mm



### Grasping forceps

Fasszange

Pinza de agarre

### Grasping forceps

13-10035

130 mm, Ø 3,5 mm



### Grasping forceps 1x2 teeth

Fasszange 1x2 Zähne

Pinza de agarre 1x2 dientes

### Grasping forceps

13-14035

130 mm, Ø 3,5 mm



### Grasping forceps 1x2 teeth

Fasszange 1x2 Zähne

Pinza de agarre 1x2 dientes

### Grasping and biopsy forceps

13-20135

130 mm, Ø 3,5 mm

### Grasping and biopsy forceps

PE Zange

Pinza de agarre y biopsia

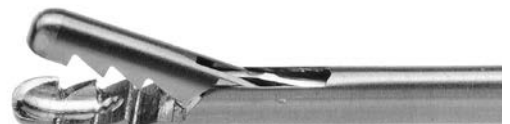

## Grasping and biopsy forceps with protective device and locking mechanism

Fass- und PE-Zangen mit Überlastungsschutz und Sperre

Pinzas de agarre y biopsia con dispositivo de protección y mecanismo de bloqueo

### Grasping and biopsy forceps

Fass- und PE-Zangen

Pinzas de agarre y biopsia

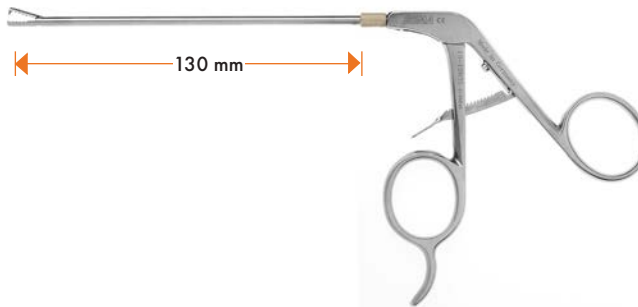

### Grasping forceps

13-02035

130 mm, Ø 3,5

### Grasping forceps with ratchet (Locking mechanism)

Fasszange mit Sperre

Pinza de agarre con mecanismo de bloqueo



### Grasping forceps

13-12035

130 mm, Ø 3,5 mm

### Grasping forceps 1x2 teeth with ratchet (Locking mechanism)

Fasszange 1x2 Zähne mit Sperre

Pinza de agarre 1x2 dientes con mecanismo de bloqueo



### Grasping forceps

13-16035

130 mm, Ø 3,5 mm

### Grasping forceps 1x2 teeth with ratchet (Locking mechanism)

Fasszange 1x2 Zähne mit Sperre

Pinza de agarre 1x2 dientes con mecanismo de bloqueo



### Grasping and biopsy forceps

13-22135

130 mm, Ø 3,5 mm

### Grasping and biopsy forceps with ratchet (Locking mechanism)

PE Zange mit Sperre

Pinza de agarre y biopsia con mecanismo de bloqueo





## Punches with scoop and protective device

### Stanzen mit Schippe und Überlastungsschutz

### Pinzas con pala y dispositivo de protección

#### Punches with scoop

##### Stanzen mit Schippe

Pinzas sacabocados con pala

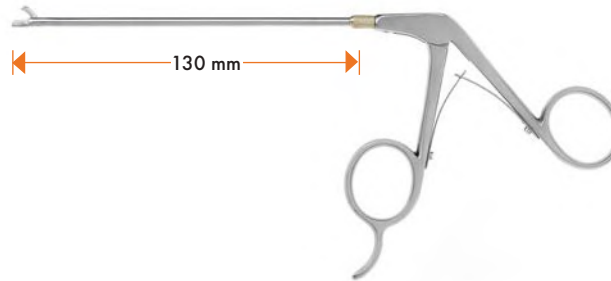

#### Punch with scoop

13-80335

130 mm, Ø 3,5



#### Punch with scoop, curved 45° right

Stanze mit Schippe, gebogen 45° rechts

Pinza sacabocados con pala, curvada 45° a la derecha

#### Punch with scoop

13-82335

130 mm, Ø 3,5 mm



#### Punch with scoop, curved 45° left

Stanze mit Schippe, gebogen 45° links

Pinza sacabocados con pala, curvada 45° a la izquierda

#### Punch with scoop

13-92335

130 mm, Ø 3,5 mm

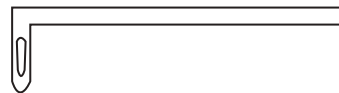

#### Punch with scoop, curved 90° left

Stanze mit Schippe, gebogen 90° links

Pinza sacabocados con pala, curvada 90° a la izquierda

#### Punch with scoop

13-90335

130 mm, Ø 3,5 mm



#### Punch with scoop, curved 90° right

Stanze mit Schippe, gebogen 90° rechts

Pinza sacabocados con pala, curvada 90° a la derecha

## Punches without scoop and protective device

Stanzen ohne Schippe und Überlastungsschutz

Pinzas sin pala y dispositivo de protección



### Punch without scoop

13-86335

130 mm, Ø 3,5 mm



### Punch without scoop, curved 45° right

Stanze ohne Schippe, gebogen 45° rechts

Pinza sacabocados sin pala, curvada 45° a la derecha



### Punch without scoop

13-88335

130 mm, Ø 3,5 mm

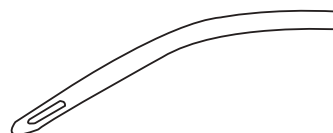

### Punch without scoop, curved 45° left

Stanze ohne Schippe, gebogen 45° links

Pinza sacabocados sin pala, curvada 45° a la izquierda

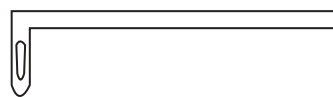

### Punch without scoop

13-98335

130 mm, Ø 3,5 mm

### Punch without scoop, curved 90° left

Stanze ohne Schippe, gebogen 90° links

Pinza sacabocados sin pala, curvada 90° a la izquierda



### Punch without scoop

13-96335

130 mm, Ø 3,5 mm

### Punch without scoop, curved 90° right

Stanze ohne Schippe, gebogen 90° rechts

Pinza sacabocados sin pala, curvada 90° a la derecha

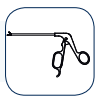

## Hook scissors with protective device

### Hakenscheren mit Überlastungsschutz

Tijera de gancho con dispositivo de protección

#### Hook scissors

##### Hakenscheren

Tijeras de gancho

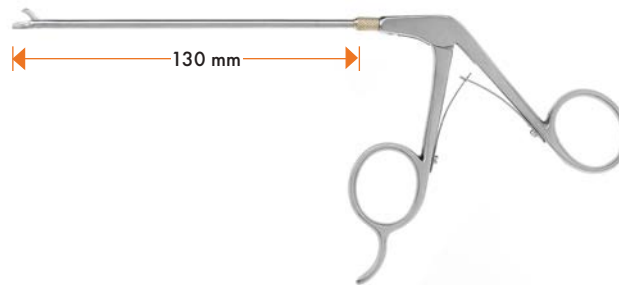

#### Hook scissors

##### 13-86435

130 mm, Ø 3,5 mm



#### Hook scissors without scoop, curved 45° right

##### Hakenschere ohne Schippe, gebogen 45° rechts

Tijera de gancho curvada 45° hacia la derecha, con pala



#### Hook scissors

##### 13-88435

130 mm, Ø 3,5 mm

#### Hook scissors without scoop, curved 45° left

##### Hakenschere ohne Schippe, gebogen 45° links

Tijera de gancho curvada 45° hacia la izquierda, con pala



#### Hook punch

##### 13-78335

130 mm, Ø 3,5 mm

#### Hook punch with scoop, 15° upward

##### Hakenstanze mit Schippe, 15° aufwärts

Pinza de gancho con boca curvada 15° hacia arriba



## Micro-scissors-punches with protective device

### Mikro-Scherenstanze

Micro tijeras con dispositivo de protección

#### Micro scissors punches

##### Mikro-Scherenstanze

Micro tijeras



#### Micro scissors

14-00435

130 mm, Ø 3,5 mm

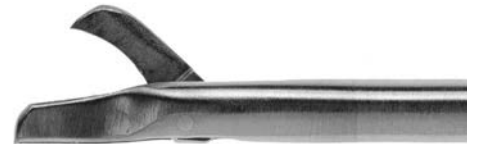
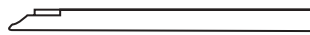

#### Micro scissors punch, straight

Mikro-Scherenstanze, gerade

Micro tijera recta

#### Micro scissors

14-01435

130 mm, Ø 3,5 mm



#### Micro scissors punch, curved right

Mikro-Scherenstanze, gebogen rechts

Micro tijera curvada a la derecha

#### Micro scissors

14-03435

130 mm, Ø 3,5 mm



#### Micro scissors punch, curved left

Mikro-Scherenstanze, gebogen links

Micro tijera curvada a la izquierda

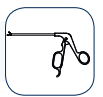

## Retrograde punches

### Retrograde stanzen

Pinzas sacabocados retrogradas

### Retrograde punches

#### Retrograde Stanzen

Pinzas sacabocados retrogradas



### Retrograde punch

14-70335

130 mm, Ø 3,5 mm



### Retrograde punch, straight, jaws right

Retrograde Stanze, gerade, Maul rechts

Pinza sacabocados retrógrada con boca a la derecha

### Retrograde punch

14-71335

130 mm, Ø 3,5 mm



### Retrograde punch, straight, jaws left

Retrograde Stanze, gerade, Maul links

Pinza sacabocados retrógrada con boca a la izquierda

## Suction punches with integrated suction channel

### Saugstanzen mit integriertem Spülkanal

Pinzas sacabocados con canal de aspiración integrado

#### Suction punches

##### Saugstanze

Pinzas sacabocados de succión

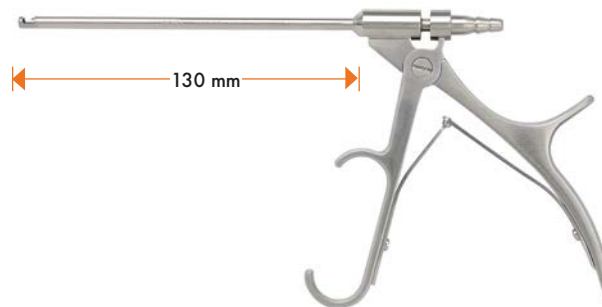

#### Suction punch

14-80350

130 mm, Ø 4,5 mm

#### Suction punch with integrated suction channel

Saugstanze mit integriertem Spülkanal

Pinza de succión con canal de aspiración integrado



#### Suction punch

14-81350

130 mm, Ø 4,5 mm

#### Suction punch with integrated suction channel

Saugstanze mit integriertem Spülkanal

Pinza de succión con canal de aspiración integrado





## Meniscus grasping forceps

### Meniskus Fasszangen

Pinzas de agarre para meniscos

#### Meniscus grasping forceps

##### Meniskus Fasszangen

Pinzas de agarre para meniscos

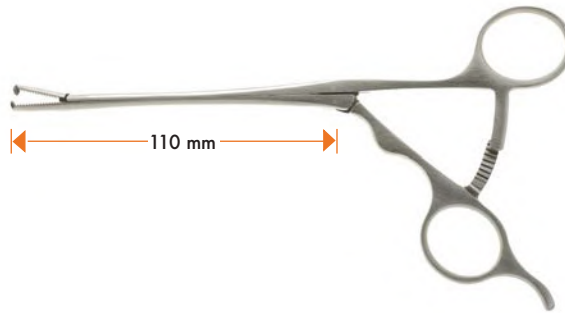

#### Meniscus grasping forceps

##### 19-00019

110 mm

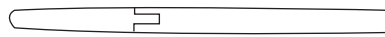

#### Meniscus grasping forceps, straight

##### Meniskus Fasszange, gerade

Pinza de agarre para meniscos, recta

#### Meniscus grasping forceps

##### 19-01019

110 mm

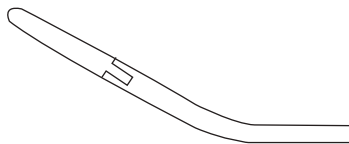

#### Meniscus grasping forceps, curved right

##### Meniskus Fasszange, rechts gebogen

Pinza de agarre para meniscos, curvada a la derecha

#### Meniscus grasping forceps

##### 19-03019

110 mm

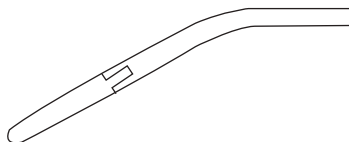

#### Meniscus grasping forceps, curved left

##### Meniskus Fasszange, links gebogen

Pinza de agarre para meniscos, curvada a la izquierda

**ACL Reconstruction**  
ACL Rekonstruktion  
Reconstrucción de LCA

**Interference screws**



**Interference screws, canulated, sterile**  
Interferenzschrauben, kanüliert, steril  
Tornillos de interferencia, canulados, estériles

Ø mm	Length Länge 20 mm Longitud	Length Länge 23 mm Longitud	Length Länge 25 mm Longitud	Length Länge 30 mm Longitud
6 mm		15-15623		
7 mm	15-15720		15-15725	15-15730
8 mm	15-15820		15-15825	15-15830
9 mm	15-15920		15-15925	15-15930

**Screw driver, for interference screws**  
Schraubendreher, für Interferenzschrauben  
Destornillador para tornillos de interferencia



**Screw driver for interference screws**

15-17114

Ø 6 mm

15-17119

Ø 7, 8, 9 mm



**Screw driver, canulated for interference screws**  
Schraubendreher, kanüliert für Interferenzschrauben  
Destornillador canulado para tornillos de interferencia



### Graft sizing block

15- 17115

Ø 6 - 10 mm



### Graft sizing block

Sehnenmessblock block

Bloque medidor de injerto

---

### Switching stick

15-17110

40 cm, Ø 4 mm



### Switching stick

Wechselstab

Guía de cambio

---

### Guide pin nitinol

15-17110

37 cm, Ø 2 mm



### Guide pin nitinol

Führungsdraht-Nitinol

Guía de nitinol

---

### Guide wire

15-17100

300 mm, Ø 1,7 mm

15-17101

300 mm, Ø 2,4 mm



### Guide wire

Zieldraht

Alambre Guía

---

---

---

---

---

---

---

---



# Small joints Kleingelenke Pequeñas articulaciones

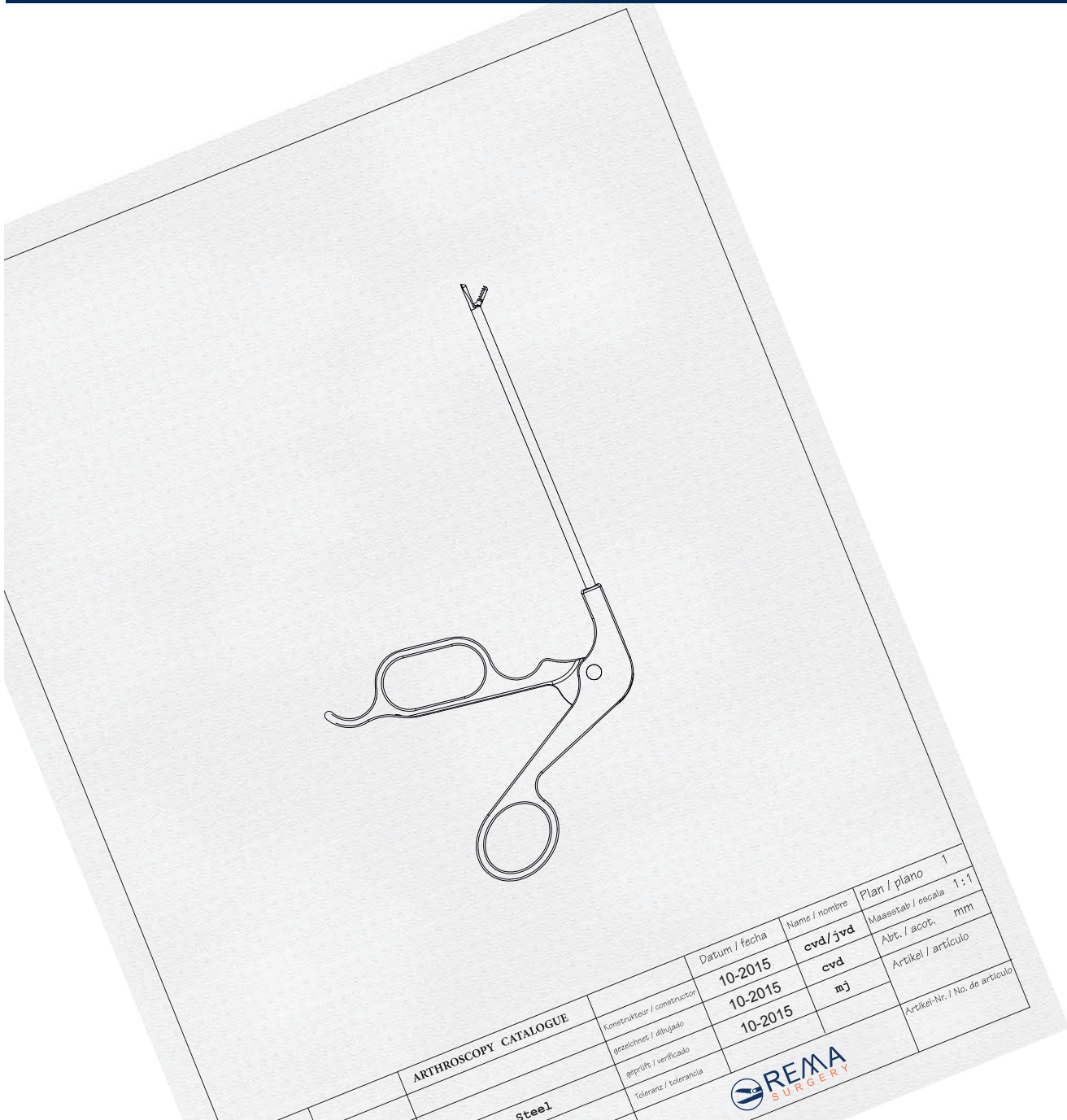



## Basic set for small joints

### Basis-Set für kleingelenke

Set básico para pequeñas articulaciones

#### Arthroscope

19-24002

96 mm, Ø 2,4 mm



#### Arthroscope view 30°

Arthroskop Blickrichtung 30°

Artroscopio 30°

#### Trocar sleeve

19-24215

98 mm, Ø 3,2 mm

#### Trocar sleeve with 2 rotatable stopcocks, suitable to optic Ø 2,4 mm

Trokarhülsen mit 2 drehbaren Absperrhähnen, passend zu Optik Ø 2,4 mm

Vaina de trócar con 2 llaves giratorias, apto para sistema óptico de Ø 2,4 mm

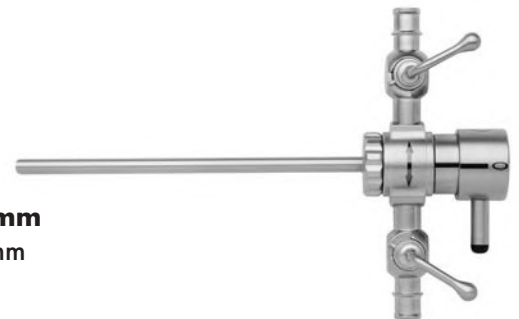

#### Trocar pointed

19-24216

98 mm, Ø 2,8 mm

#### Trocar pointed, suitable to trocar sleeve Ø 3,2 mm

Trokar spitz, passend zu Trokarhülsen Ø 3,2 mm

Trócar puntiagudo para vaina de trócar de Ø 3,2 mm



#### Trocar blunt

19-24217

98 mm, Ø 2,8 mm

#### Trocar blunt, suitable to trocar sleeve Ø 3,2 mm

Trokar stumpf, passend zu Trokarhülsen Ø 3,2

Trócar romo para vaina de trócar Ø 3,2 mm



#### Fibre light cable

31-00152

2,3 m

#### Fibre light cable, REMA, STORZ

Fiberlichtkabel, REMA, STORZ

Cable de fibra óptica REMA, STORZ





### Hook probe

19-01125 + 19-00130

220 mm, Ø 2,5 mm



### Hook probe graduated

Hakensonde graduiert

Gancho palpador graduado

### Straight hook punch

13-20327

30 mm, Ø 2,7 mm



### Hook punch, straight, blunt

Hakenstanze, gerade, stumpf

Pinza sacabocados de gancho, recta, romo

### Grasping forceps

13-00027

130 mm, Ø 2,7 mm



### Grasping forceps

Fasszange

Pinza de agarre y biopsia

### Curved basket punch

14-64335

130 mm, Ø 3,5 mm



### Basket punch, curved 90° right, small

Korbstanze gebogen 90° rechts, klein

Pinza sacabocados de canasta curvada 90° hacia la derecha, pequeña

7,0 x 1,8 mm

### Curved basket punch

11-66335

130 mm, Ø 3,5 mm



### Basket punch curved 90° left, small

Korbstanze gebogen 90° links, klein

Pinza sacabocados tipo canasta curvada 90° hacia la izquierda, pequeña

7,0 x 1,8 mm

### **Curved hook punch**

**13-23327**

130 mm, Ø 2,7 mm



### **Hook punch curved 30° left, blunt**

**Hakenstanze gebogen 30° links, stumpf**

Pinza sacabocados de gancho, curvada 30° a la izquierda, romo

### **Curved hook punch**

**13-21327**

130 mm, Ø 2,7 mm



### **Hook punch curved 30° right, blunt**

**Hakenstanze gebogen 30° rechts, stumpf**

Pinza sacabocados de gancho, curvada 30° a la derecha, romo

### **Straight scissors**

**13-00427**

130 mm, Ø 2,7 mm



### **Hook scissors, straight**

**Hakenschere, gerade**

Tijera de gancho, recta

### **Aluminium ¾ container**

**85-212.100**

465 x 280 x 100 mm

### **Aluminium ¾ container**

**Aluminium ¾ Container**

Contenedor ¾ de Aluminio



More information in REMASTERI catalog



**Arthroscope**

Arthroskop Ø 2,7 mm  
Artroscopio

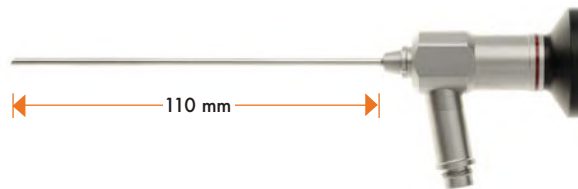

HD

**Autoclavable**  
Autoklavierbar 134°C  
Autoclavable

19-27002  
110 mm, Ø 2,7 mm

**Arthroscope, view 30°**  
Arthroscope Blickrichtung 30°  
Artroscopio 30°

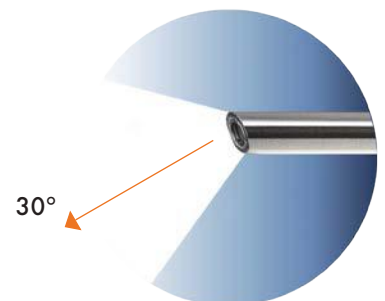

**Arthroscope**

Arthroskop Ø 2,4 mm  
Artroscopio

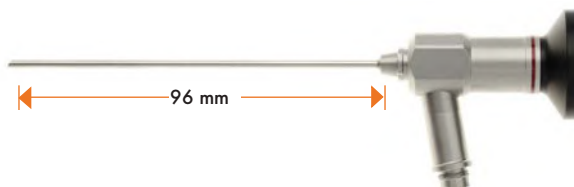

HD

**Autoclavable**  
Autoklavierbar 134°C  
Autoclavable

19-24002  
96 mm, Ø 2,4 mm

**Arthroscope, view 30°**  
Arthroscope Blickrichtung 30°  
Artroscopio 30°

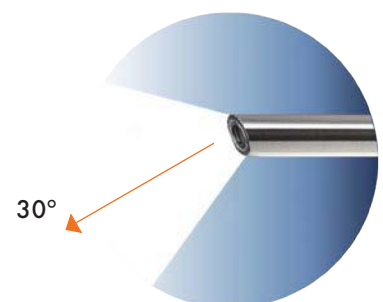

**Arthroscope**

Arthroskop Ø 1,9 mm  
Artroscopio

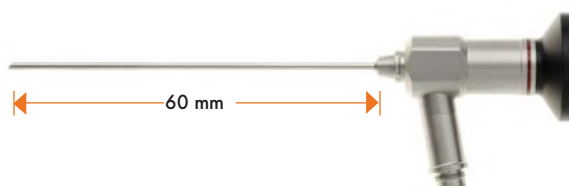

HD

**Autoclavable**  
Autoklavierbar 134°C  
Autoclavable

19-19002  
60 mm, Ø 1,9 mm

**Arthroscope, view 30°**  
Arthroskop Blickrichtung 30°  
Arthroskopio 30°

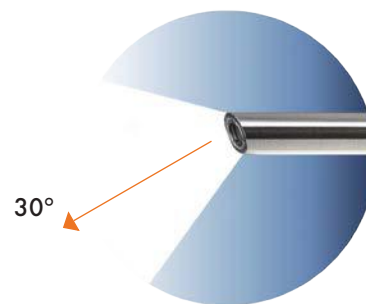

## Trocar sleeves and trocars

### Trokarhülsen und Trokare

### Vaina de trocar y trócares

**Trocar sleeve**  
19-27215  
110 mm, Ø 3,8 mm

**Trocar sleeve with 2 rotatable stopcocks, suitable to optic Ø 2,7 mm**  
Trokarhülsen mit 2 drehbaren Absperrhähnen, passend zu Optik Ø 2,7 mm  
Vaina de trocar con 2 llaves giratorias, apto para sistema óptico de Ø 2,7 mm



**Trocar pointed**  
19-27216  
110 mm, Ø 2,9 mm

**Trocar pointed, suitable to trocar sleeve Ø 3,8 mm**  
Trokar spitz, passend zu Trokarhülsen Ø 3,8 mm  
Trócar puntiagudo para vaina de trocar Ø 3,8 mm



**Trocar blunt**  
19-27217  
110 mm, Ø 2,9 mm

**Trocar blunt, suitable to trocar sleeve Ø 3,8 mm**  
Trokar stumpf, passend zu Trokarhülsen Ø 3,8 mm  
Trócar romo para vaina de trocar Ø 3,8 mm



**Trocar sleeve**  
19-24215  
98 mm, Ø 3,2 mm

**Trocar sleeve with 2 rotatable stopcocks, suitable to optic Ø 2,4 mm**  
Trokarhülsen mit 2 drehbaren Absperrhähnen, passend zu Optik Ø 2,4 mm  
Vaina de trocar con 2 llaves giratorias, apto para sistema óptico de Ø 2,4 mm





### Trocar pointed

19-24216

98 mm, Ø 2,8 mm



### Trocar pointed, suitable to trocar sleeve Ø 3,2 mm

Trokar spitz, passend zu Trokarhülsen Ø 3,2 mm

Trócar puntiagudo para vaina de trócar Ø 3,2 mm

### Trocar blunt

19-24217

98 mm, Ø 2,8 mm



### Trocar blunt, suitable to trocar sleeve Ø 3,2 mm

Trokar stumpf, passend zu Trokarhülsen Ø 3,2 mm

Trócar romo para vaina de trócar Ø 3,2 mm

### Trocar sleeve

19-19215

58 mm, Ø 2,5 mm



### Trocar sleeve with 2 rotatable stopcocks, suitable to optic Ø 1,9mm

Trokarhülsen mit 2 drehbaren Absperrhähnen, passend zu Optik Ø 1,9 mm

Vaina de trócar con 2 llaves giratorias, apto para sistema óptico de Ø 1,9 mm

### Trocar pointed

19-19216

58 mm, Ø 2,1 mm



### Trocar pointed, suitable to trocar sleeve Ø 2,5 mm

Trokar spitz, passend zu Trokarhülsen Ø 2,5 mm

Trócar romo para vaina de trócar Ø 2,5 mm

### Trocar blunt

19-19217

58 mm, Ø 2,1 mm



### Trocar blunt, suitable to trocar sleeve Ø 2,5 mm

Trokar stumpf, passend zu Trokarhülsen Ø 2,5 mm

Trócar romo para vaina de trócar Ø 2,5 mm

## Hook punches with protective device

### Hakenstanzen mit Überlastungsschutz

Pinzas sacabocados de gancho con dispositivo de protección

#### Hook punches

##### Hakenstanzen

Pinzas sacabocados de gancho

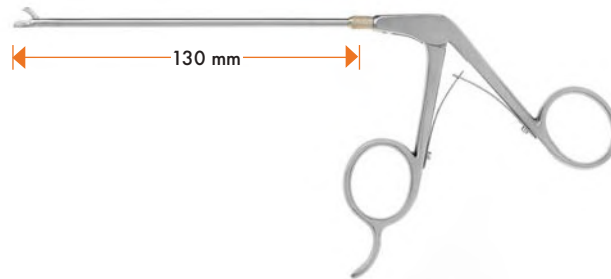

#### Straight hook punch

13-00327

130 mm, Ø 2,7 mm

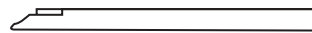

#### Hook punch, straight, with scoop

##### Hakenstanze, gerade, mit Schaufel

Pinza sacabocados de gancho, recta con pala

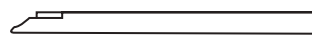

#### Straight hook punch

13-20327

130 mm, Ø 2,7 mm



#### Hook punch, straight, blunt

##### Hakenstanze, gerade, stumpf

Pinza sacabocados de gancho, recta, romo

#### Straight hook punch

13-40327

130 mm, Ø 2,7 mm

#### Hook punch, straight, flat

##### Hakenstanze, gerade, flach

Pinza sacabocados de gancho, recta, plana



## Curved hook punch

13-01327

130 mm, Ø 2,7 mm



### Hook punch curved 30° right, with scoop

Hakenstanze gebogen 30° rechts mit Schaufel

Pinza sacabocados de gancho, curvada 30° a la derecha con pala

## Curved hook punch

13-21327

130 mm, Ø 2,7 mm



### Hook punch curved 30° right, blunt

Hakenstanze gebogen 30° rechts, stumpf

Pinza sacabocados de gancho, curvada 30° a la derecha, romo

## Curved hook punch

13-41327

130 mm, Ø 2,7 mm



### Hook punch curved 30° right, flat

Hakenstanze gebogen 30° rechts, flach

Pinza sacabocados de gancho, curvada 30° a la derecha, plana

## Curved hook punch

13-03327

130 mm, Ø 2,7 mm



### Hook punch curved 30° left, with scoop

Hakenstanze gebogen 30° links, mit Schaufel

Pinza sacabocados de gancho, curvada 30° a la izquierda con pala

## Curved hook punch

13-23327

130 mm, Ø 2,7 mm



### Hook punch curved 30° left, blunt

Hakenstanze gebogen 30° links, stumpf

Pinza sacabocados de gancho, curvada 30° a la izquierda, romo

## Curved hook punch

13-43327

130 mm, Ø 2,7 mm



### Hook punch curved 30° left, flat

Hakenstanze gebogen 30° links, flach

Pinza sacabocados de gancho, curvada 30° a la izquierda, plana



### Curved hook punch

13-05327

130 mm, Ø 2,7 mm

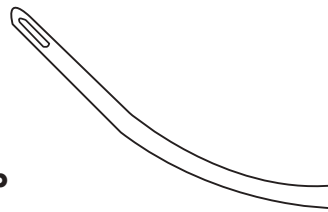

### Hook punch curved 45° right, with scoop

Hakenstanze gebogen 45° rechts mit Schaufel

Pinza sacabocados de gancho, curvada 45° a la derecha con pala

### Curved hook punch

13-25327

130 mm, Ø 2,7 mm

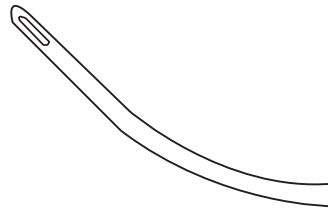

### Hook punch curved 45° right, blunt

Hakenstanze gebogen 45° rechts, stumpf

Pinza sacabocados de gancho, curvada 45° a la derecha, romo

### Curved hook punch

13-45327

130 mm, Ø 2,7 mm

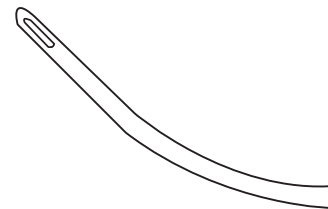

### Hook punch curved 45° right, flat

Hakenstanze gebogen 45° rechts, flach

Pinza sacabocados de gancho, curvada 45° a la derecha, plana

### Curved hook punch

13-07327

130 mm, Ø 2,7 mm

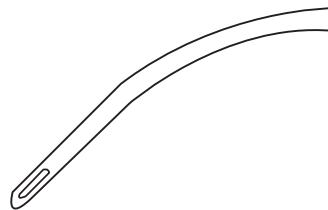

### Hook punch curved 45° left, with scoop

Hakenstanzen gebogen 45° links, mit Schaufel

Pinza sacabocados de gancho, curvada 45° a la izquierda con pala

### Curved hook punch

13-27327

130 mm, Ø 2,7 mm

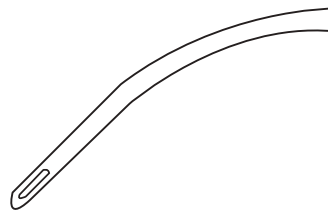

### Hook punch curved 45° left, blunt

Hakenstanzen gebogen 45° links, stumpf

Pinza sacabocados de gancho, curvada 45° a la izquierda, romo

### Curved hook punch

13-47327

130 mm, Ø 2,7 mm

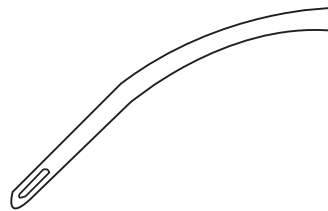

### Hook punch curved 30° left, flat

Hakenstanze gebogen 30° links, flach

Pinza sacabocados de gancho, curvada 30° a la izquierda, plana



### Curved hook punch

13-09327

130 mm, Ø 2,7 mm

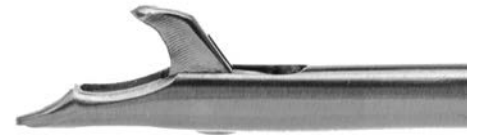

### Hook punch curved 7° upward, with scoop

Hakenstanze 7° aufwärts, mit Schaufel

Pinza sacabocados de gancho, curvada 7° hacia arriba con pala

### Curved hook punch

13-29327

130 mm, Ø 2,7 mm



### Hook punch curved 7° upward, blunt

Hakenstanze gebogen 7° aufwärts, stumpf

Pinza sacabocados de gancho, curvada 7° hacia arriba, romo

### Curved hook punch

13-49327

130 mm, Ø 2,7 mm



### Hook punch curved 7° upward, flat

Hakenstanze gebogen 7° aufwärts, flach

Pinza sacabocados de gancho, curvada 7° hacia arriba, plana

### Curved hook punch

13-11327

130 mm, Ø 2,7 mm



### Hook punch curved 7° downward with scoop

Hakenstanze gebogen 7° abwärts mit Schaufel

Pinza sacabocados de gancho, curvada 7° hacia abajo con pala

### Curved hook punch

13-31327

130 mm, Ø 2,7 mm



### Hook punch curved 7° downward, blunt

Hakenstanze gebogen 7° abwärts, stumpf

Pinza sacabocados de gancho, curvada 7° hacia abajo, romo

### Curved hook punch

13-51327

130 mm, Ø 2,7 mm



### Hook punch curved 7° downward, flat

Hakenstanze gebogen 7° abwärts, flach

Pinza sacabocados de gancho, curvada 7° hacia abajo, plana

**Curved hook punch**

13-13327

130 mm, Ø 2,7 mm



**Hook punch curved 15° upward with scoop**

Hakenstanze gebogen 15° aufwärts, mit Schaufel

Pinza sacabocados de gancho, curvada 15° hacia arriba con pala

**Curved hook punch**

13-33327

130 mm, Ø 2,7 mm



**Hook punch curved 15° upward, blunt**

Hakenstanze gebogen 15° aufwärts, stumpf

Pinza sacabocados de gancho, curvada 15° hacia arriba, romo

**Curved hook punch**

13-53327

130 mm, Ø 2,7 mm



**Hook punch curved 15° upward, flat**

Hakenstanze gebogen 15° aufwärts, flach

Pinza sacabocados de gancho, curvada 15° hacia arriba, plana

**Curved hook punch**

13-15327

130 mm, Ø 2,7 mm



**Hook punch curved 15° downward with scoop**

Hakenstanze gebogen 15° abwärts, mit Schaufel

Pinza sacabocados de gancho, curvada 15° hacia abajo con pala

**Curved hook punch**

13-35327

130 mm, Ø 2,7 mm



**Hook punch curved 15° downward, blunt**

Hakenstanze gebogen 15° abwärts, stumpf

Pinza sacabocados de gancho, curvada 15° hacia abajo, romo

**Curved hook punch**

13-55327

130 mm, Ø 2,7 mm



**Hook punch curved 15° downward, flat**

Hakenstanze gebogen 15° abwärts, flach

Pinza sacabocados de gancho, curvada 15° hacia abajo, plana



## Hook scissors with protective device Hakenscheren mit Überlastungsschutz Tijeras de gancho con dispositivo de protección

**Hook scissors**  
Hakenscheren  
Tijeras de gancho



**Straight scissors**

13-00427  
130 mm, Ø 2,7 mm

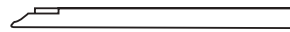

**Hook scissors, straight**  
Hakenschere, gerade  
Tijera de gancho, recta

**Curved scissors**

13-01427  
130 mm, Ø 2,7 mm



**Hook scissors, curved 30° right**  
Hakenschere, gebogen 30° rechts  
Tijera de gancho, curvada 30° a la derecha

**Curved scissors**

13-03427  
130 mm, Ø 2,7 mm

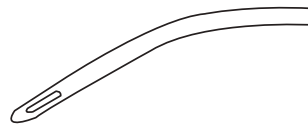

**Hook scissors, curved 30° left**  
Hakenschere, gebogen 30° links  
Tijera de gancho, curvada 30° a la izquierda

**Curved scissors**

13-05427  
130 mm, Ø 2,7 mm

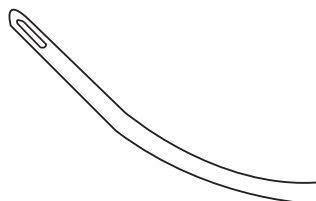

**Hook scissors, curved 45° right**  
Hakenschere, gebogen 45° rechts  
Tijera de gancho, curvada 45° a la derecha

**Curved scissors**

13-07427

130 mm, Ø 2,7 mm

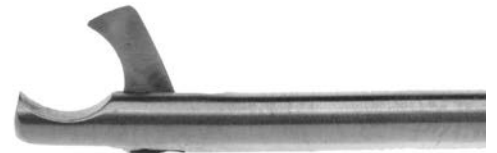
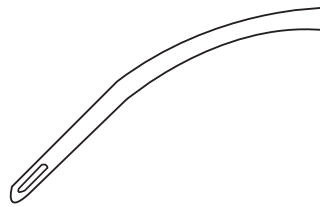

**Hook scissors, curved 45° left**

Hakenschere, gebogen 45° links

Tijera de gancho, curvada 45° a la izquierda

**Curved scissors**

13-09427

130 mm, Ø 2,7 mm



**Hook scissors, curved 7° upward**

Hakenschere, gebogen 7° aufwärts

Tijera de gancho, curvada 7° hacia arriba

**Curved scissors**

13-11427

130 mm, Ø 2,7 mm



**Hook scissors, curved 7° downward**

Hakenschere, gebogen 7° abwärts

Tijera de gancho, curvada 7° hacia abajo

**Curved scissors**

13-13427

130 mm, Ø 2,7 mm



**Hook scissors, curved 15° upward**

Hakenschere, gebogen 15° aufwärts

Tijera de gancho, curvada 15° hacia arriba

**Curved scissors**

13-15427

130 mm, Ø 2,7 mm



**Hook scissors, curved 15° downward**

Hakenschere, gebogen 15° abwärts

Tijera de gancho, curvada 15° hacia abajo



## Grasping and biopsy forceps with protective device

Fass- und PE- Zangen mit Überlastungsschutz

Pinzas de agarre y biopsia con dispositivo de protección

### Grasping and biopsy forceps

Fass- und PE Zangen

Pinzas de agarre y biopsia

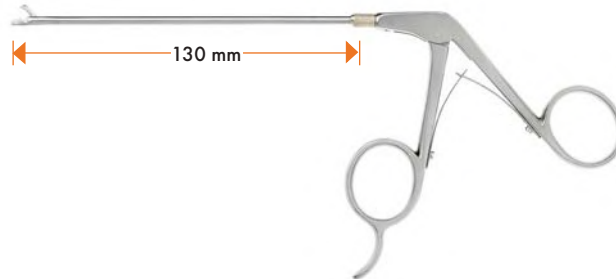

### Grasping forceps

13-00027

130 mm, Ø 2,7 mm



### Grasping forceps

Fasszange

Pinza de agarre y biopsia

## Grasping and biopsy forceps with protective device and locking mechanism

Fass- und PE- Zangen mit Überlastungsschutz und Sperre

Pinzas de agarre y biopsia con dispositivo de protección y mecanismo de bloqueo

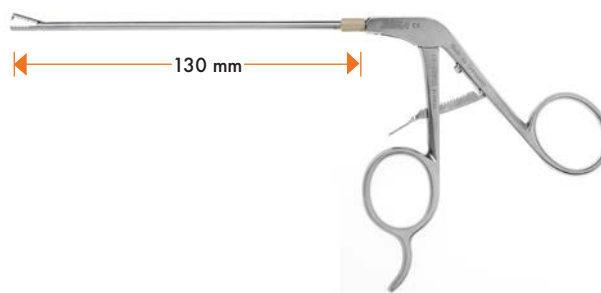

### Grasping forceps

13-02027

130 mm, Ø 2,7 mm



### Grasping forceps with ratchet (Locking mechanism)

Fasszange mit Sperre

Pinza de agarre y biopsia con mecanismo de bloqueo

## Hook punches with protective device

### Hakenstanze mit Überlastungsschutz

Pinza de gancho con dispositivo de protección

#### Hook punch

##### Hakenstanze

Pinza de gancho

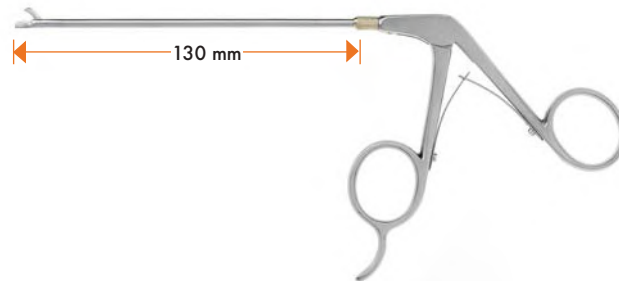

#### Hook punch

##### 13-78327

130 mm, Ø 2,7 mm

#### Hook punch, curved 15° upward

##### Hakenstanze, gebogen 15° aufwärts

Pinza de gancho con boca curvada 15° hacia arriba



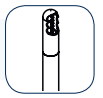

# Shaver blades and burrs

## Rotationsmesser und Fräser

### Cuchillas y fresas rotatorias

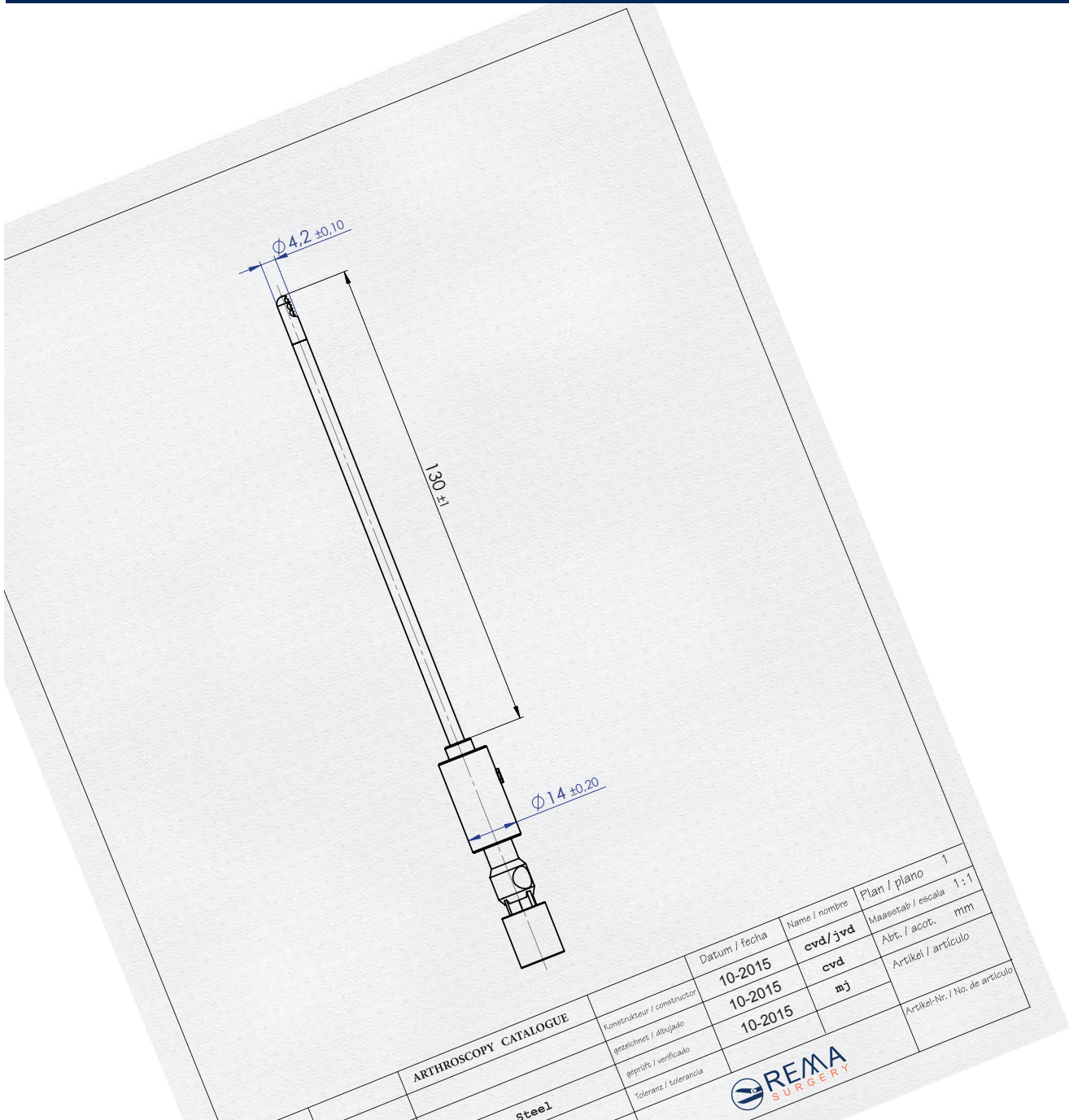



**Orientation marking**  
Orientierungsmarkierung

Marca de orientación

**Wide variety of geometric forms for shaver blades and burrs**

Viele geometrischen Formen für Rotationsmesser und Fräser

Amplia variedad de formas geométricas para cuchillas y fresas rotatorias

**Compatible with different manufacturers of shaver systems**

Kompatibel mit verschiedenen Herstellern von Shaver Systemen

Compatible con diversos fabricantes de sistemas shaver

**Color code for identify different geometry forms of shaver blades and burrs**

Farbcode für die Identifizierung verschiedener geometrischer Formen von Rotationsmessern und Fräsern

Código de color para identificar las diferentes formas geométricas de las cuchillas y fresas rotatorias



REMA shaver blades available in autoclavable and sterile versions for these systems:



**Note: the marking is useful for orientation, not for measure.**  
Hinweis: die Markierung ist hilfreich für die Orientierung, nicht zum Messen.  
Nota: el marcado solo es útil para orientación, no para medir.

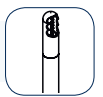



## Shaver blades for REMA, Linvatec, Concept, Arthrex, Atlantec



For small joints, length 80 mm, autoclavable, reusable



	Description	Ø 2,5 mm	Ø 3,4 mm	Ø 4,2 mm	Ø 5,5 mm	
	Aggressive Full-Radius Resector	15-60210				● ●
	Full-Radius Resector	15-60230				○ ○



## Shaver blades for REMA, Linvatec, Concept, Arthrex, Atlantec



Length 130 mm, autoclavable, reusable



	Description	Ø 2,5 mm	Ø 3,4 mm	Ø 4,2 mm	Ø 5,5 mm	
	Aggressive Full-Radius Resector		15-60310	15-60410	15-60510	● ●
	Double Aggressive Full-Radius			15-60415	15-60515	○ ●
	Meniscus Cutter		15-60320	15-60420	15-60520	● ●
	End Cutter			15-60425	15-60525	○ ●
	Full-Radius Resector		15-60330	15-60430	15-60530	○ ○
	Incisor		15-60340	15-60440	15-60540	● ●
	Cutter			15-60450		● ○

	Description	Ø 2,5 mm	Ø 3,4 mm	Ø 4,2 mm	Ø 5,5 mm	
	Round Burr			15-60460	15-60560	● ●
	Tapered Burr				15-60570	● ●
	Oval Burr			15-60480	15-60580	● ●

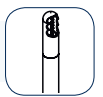

Shaver blades for REMA, Linvatec, Concept, Arthrex, Atlantec



Length 130 mm, sterile, single use





	Description	Ø 2,5 mm	Ø 3,4 mm	Ø 4,2 mm	Ø 5,5 mm	
	Aggressive Full-Radius Resector		15-60310S	15-60410S	15-60510S	● ●
	Double Aggressive Full-Radius			15-60415S	15-60515S	○ ●
	Meniscus Cutter		15-60320S	15-60420S	15-60520S	● ●
	End Cutter			15-60425S	15-60525S	○ ●
	Full-Radius Resector		15-60330S	15-60430S	15-60530S	○ ○
	Incisor		15-60340S	15-60440S	15-60540S	● ●
	Cutter			15-60450S		● ○
	Round Burr			15-60460S	15-60560S	● ●
	Tapered Burr				15-60570S	● ●
	Oval Burr			15-60480S	15-60580S	● ●

Curved shaver blades for REMA, Linvatec, Concept, Arthrex, Atlantec



Length 130 mm, autoclavable, reusable



	Description	Ø 2,5 mm	Ø 3,4 mm	Ø 4,2 mm	Ø 5,5 mm	
	Aggressive Full-Radius Resector			15-60411		● ●
	Full-Radius Resector			15-60431		○ ○
	Incisor			15-60441		● ●

Curved shaver blades for REMA, Linvatec, Concept, Arthrex, Atlantec



Length 130 mm, sterile, single use



	Description	Ø 2,5 mm	Ø 3,4 mm	Ø 4,2 mm	Ø 5,5 mm	
	Aggressive Full-Radius Resector			15-60411S		● ●
	Full-Radius Resector			15-60431S		○ ○
	Incisor			15-60441S		● ●

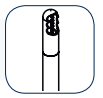

Shaver blades for REMA, Linvatec, Concept, Arthrex, Atlantec

Length 210 mm, autoclavable, reusable





	Description	Ø 3,4 mm	Ø 4,2 mm	Ø 5,5 mm	
	Aggressive Full-Radius Resector	15-70310	15-70410	15-70510	● ●
	Meniscus Cutter	15-70320	15-70420	15-70520	● ●
	Full-Radius Resector	15-70330	15-70430	15-70530	○ ○
	Incisor	15-70340	15-70440	15-70540	● ●
	Round Burr			15-70560	● ●

### Shaver blades for REMA and Arthrex APS II



For small joints, length 80 mm, autoclavable, reusable



	Description	Ø 2,5 mm	Ø 3,4 mm	Ø 4,2 mm	Ø 5,5 mm	
	Aggressive Full-Radius Resector	15-61210				●●
	Full-Radius Resector	15-61230				○○

### Shaver blades for REMA and Arthrex APS II





Length 130 mm, autoclavable, reusable



	Description	Ø 2,5 mm	Ø 3,4 mm	Ø 4,2 mm	Ø 5,5 mm	
	Aggressive Full-Radius Resector		15-61310	15-61410	15-61510	●●
	Double Aggressive Full-Radius			15-61415	15-61515	○●
	Meniscus Cutter		15-61320	15-61420	15-61520	●●
	End Cutter			15-61425	15-61525	○●
	Full-Radius Resector		15-61330	15-61430	15-61530	○○
	Incisor		15-61340	15-61440	15-61540	●●
	Cutter			15-61450		●○



	Description	Ø 2,5 mm	Ø 3,4 mm	Ø 4,2 mm	Ø 5,5 mm	
	Round Burr			15-61460	15-61560	● ●
	Tapered Burr				15-61570	● ●
	Oval Burr			15-61480	15-61580	● ●



Shaver blades for REMA and Arthrex APS II

Length 130 mm, sterile, single use 



	Description	Ø 2,5 mm	Ø 3,4 mm	Ø 4,2 mm	Ø 5,5 mm	
	Aggressive Full-Radius Resector		15-61310S	15-61410S	15-61510S	● ●
	Double Aggressive Full-Radius			15-61415S	15-61515S	○ ●
	Meniscus Cutter		15-61320S	15-61420S	15-61520S	● ●
	End Cutter			15-61425S	15-61525S	○ ●
	Full-Radius Resector		15-61330S	15-61430S	15-61530S	○ ○
	Incisor		15-61340S	15-61440S	15-61540S	● ●
	Cutter			15-61450S		● ○
	Round Burr			15-61460S	15-61560S	● ●
	Tapered Burr				15-61570S	● ●
	Oval Burr			15-61480S	15-61580S	● ●

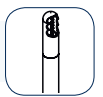



## Curved shaver blades for REMA and Arthrex APS II



Length 130 mm, autoclavable, reusable





	Description	Ø 2,5 mm	Ø 3,4 mm	Ø 4,2 mm	Ø 5,5 mm	
	Aggressive Full-Radius Resector			15-61411		●●
	Full-Radius Resector			15-61431		○○
	Incisor			15-61441		●●

## Curved shaver blades for REMA and Arthrex APS II



Length 130 mm, sterile, single use



	Description	Ø 2,5 mm	Ø 3,4 mm	Ø 4,2 mm	Ø 5,5 mm	
	Aggressive Full-Radius Resector			15-61411S		●●
	Full-Radius Resector			15-61431S		○○
	Incisor			15-61441S		●●

# Shaver blades for REMA and Arthrex APS II

Length 210 mm, autoclavable, reusable



	Description	Ø 3,4 mm	Ø 4,2 mm	Ø 5,5 mm	
	Aggressive Full-Radius Resector	15-71310	15-71410	15-71510	● ●
	Meniscus Cutter	15-71320	15-71420	15-71520	● ●
	Full-Radius Resector	15-71330	15-71430	15-71530	○ ○
	Incisor	15-71340	15-71440	15-71540	● ●
	Round Burr			15-71560	● ●

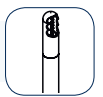



## Shaver blades for Dyonics EP-1 (smith&nephew)



For small joints, length 80 mm, autoclavable, reusable



	Description	Ø 2,5 mm	Ø 3,4 mm	Ø 4,2 mm	Ø 5,5 mm	
	Aggressive Full-Radius Resector	15-62210				●●
	Full-Radius Resector	15-62230				○○



## Shaver blades for Dyonics EP-1 (smith&nephew)



Length 130 mm, autoclavable, reusable



	Description	Ø 2,5 mm	Ø 3,4 mm	Ø 4,2 mm	Ø 5,5 mm	
	Aggressive Full-Radius Resector		15-62310	15-62410	15-62510	●●
	Double Aggressive Full-Radius			15-62415	15-62515	○●
	Meniscus Cutter		15-62320	15-62420	15-62520	●●
	End Cutter			15-62425	15-62525	○●
	Full-Radius Resector		15-62330	15-62430	15-62530	○○
	Incisor		15-62340	15-62440	15-62540	●●
	Cutter			15-62450		●○

	Description	Ø 2,5 mm	Ø 3,4 mm	Ø 4,2 mm	Ø 5,5 mm	
	Round Burr			15-62460	15-62560	● ●
	Tapered Burr				15-62570	● ●
	Oval Burr			15-62480	15-62580	● ●

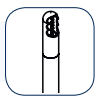

## Shaver blades for Dyonics EP-1 (smith&nephew)

Length 130 mm, sterile, single use 





	Description	Ø 2,5 mm	Ø 3,4 mm	Ø 4,2 mm	Ø 5,5 mm	
	Aggressive Full-Radius Resector		15-62310S	15-62410S	15-62510S	● ●
	Double Aggressive Full-Radius			15-62415S	15-62515S	○ ●
	Meniscus Cutter		15-62320S	15-62420S	15-62520S	● ●
	End Cutter			15-62425S	15-62525S	○ ●
	Full-Radius Resector		15-62330S	15-62430S	15-62530S	○ ○
	Incisor		15-62340S	15-62440S	15-62540S	● ●
	Cutter			15-62450S		● ○
	Round Burr			15-62460S	15-62560S	● ●
	Tapered Burr				15-62570S	● ●
	Oval Burr			15-62480S	15-62580S	● ●

Curved shaver blades for Dyonics EP-1 (smith&nephew)



Length 130 mm, autoclavable, reusable





	Description	Ø 2,5 mm	Ø 3,4 mm	Ø 4,2 mm	Ø 5,5 mm	
	Aggressive Full-Radius Resector			15-62411		● ●
	Full-Radius Resector			15-62431		○ ○
	Incisor			15-62441		● ●

Curved shaver blades for Dyonics EP-1 (smith&nephew)



Length 130 mm, sterile, single use



	Description	Ø 2,5 mm	Ø 3,5 mm	Ø 4,2 mm	Ø 5,5 mm	
	Aggressive Full-Radius Resector			15-62411S		● ●
	Full-Radius Resector			15-62431S		○ ○
	Incisor			15-62441S		● ●

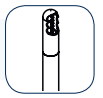

## Shaver blades for Dyonics EP-1 (smith&nephew)



Length 210 mm, autoclavable, reusable



	Description	Ø 3,4 mm	Ø 4,2 mm	Ø 5,5 mm	
	Aggressive Full-Radius Resector	15-72310	15-72410	15-72510	● ●
	Meniscus Cutter	15-72320	15-72420	15-72520	● ●
	Full-Radius Resector	15-72330	15-72430	15-72530	○ ○
	Incisor	15-72340	15-72440	15-72540	● ●
	Round Burr			15-72560	● ●





Shaver blades for Dyonics PS3500 EP (smith&nephew)



For small joints, length 80 mm, autoclavable, reusable



	Description	Ø 2,5 mm	Ø 3,4 mm	Ø 4,2 mm	Ø 5,5 mm	
	Aggressive Full-Radius Resector	15-64210				● ●
	Full-Radius Resector	15-64230				○ ○

Shaver blades for Dyonics PS3500 EP (smith&nephew)





Length 130 mm, autoclavable, reusable



	Description	Ø 2,5 mm	Ø 3,4 mm	Ø 4,2 mm	Ø 5,5 mm	
	Aggressive Full-Radius Resector		15-64310	15-64410	15-64510	● ●
	Double Aggressive Full-Radius			15-64415	15-64515	○ ●
	Meniscus Cutter		15-64320	15-64420	15-64520	● ●
	End Cutter			15-64425	15-64525	○ ●
	Full-Radius Resector		15-64330	15-64430	15-64530	○ ○
	Incisor		15-64340	15-64440	15-64540	● ●
	Cutter			15-64450		● ○



	Description	Ø 2,5 mm	Ø 3,4 mm	Ø 4,2 mm	Ø 5,5 mm	
	Round Burr			15-64460	15-64560	● ●
	Tapered Burr				15-64570	● ●
	Oval Burr			15-64480	15-64580	● ●

# Shaver blades for Dyonics PS3500 EP (smith&nephew)

Length 130 mm, sterile, single use 



	Description	Ø 2,5 mm	Ø 3,4 mm	Ø 4,2 mm	Ø 5,5 mm	
	Aggressive Full-Radius Resector		15-64310S	15-64410S	15-64510S	● ●
	Double Aggressive Full-Radius			15-64415S	15-64515S	○ ●
	Meniscus Cutter		15-64320S	15-64420S	15-64520S	● ●
	End Cutter			15-64425S	15-64525S	○ ●
	Full-Radius Resector		15-64330S	15-64430S	15-64530S	○ ○
	Incisor		15-64340S	15-64440S	15-64540S	● ●
	Cutter			15-64450S		● ○
	Round Burr			15-64460S	15-64560S	● ●
	Tapered Burr				15-64570S	● ●
	Oval Burr			15-64480S	15-64580S	● ●

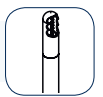



Curved shaver blades for Dyonics PS3500 EP (smith&nephew)



Length 130 mm, autoclavable, reusable





	Description	Ø 2,5 mm	Ø 3,4 mm	Ø 4,2 mm	Ø 5,5 mm	
	Aggressive Full-Radius Resector			15-64411		● ●
	Full-Radius Resector			15-64431		○ ○
	Incisor			15-64441		● ●

Curved shaver blades for Dyonics PS3500 EP (smith&nephew)



Length 130 mm, sterile, single use



	Description	Ø 2,5 mm	Ø 3,4 mm	Ø 4,2 mm	Ø 5,5 mm	
	Aggressive Full-Radius Resector			15-64411S		● ●
	Full-Radius Resector			15-64431S		○ ○
	Incisor			15-64441S		● ●

# Shaver blades for Dyonics PS3500 EP (smith&nephew)



Length 210 mm, autoclavable, reusable



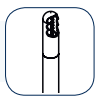

	Description	Ø 3,4 mm	Ø 4,2 mm	Ø 5,5 mm	
	Aggressive Full-Radius Resector	15-74310	15-74410	15-74510	● ●
	Meniscus Cutter	15-74320	15-74420	15-74520	● ●
	Full-Radius Resector	15-74330	15-74430	15-74530	○ ○
	Incisor	15-74340	15-74440	15-74540	● ●
	Round Burr			15-74560	● ●



## Shaver blades for Aesculap

For small joints, length 80 mm, autoclavable, reusable





	Description	Ø 2,5 mm	Ø 3,4 mm	Ø 4,2 mm	Ø 5,5 mm	
	Aggressive Full-Radius Resector	15-65210				● ●
	Full-Radius Resector	15-65230				○ ○

## Shaver blades for Aesculap

Length 130 mm, autoclavable, reusable



	Description	Ø 2,5 mm	Ø 3,4 mm	Ø 4,2 mm	Ø 5,5 mm	
	Aggressive Full-Radius Resector		15-65310	15-65410	15-65510	● ●
	Double Aggressive Full-Radius			15-65415	15-65515	○ ●
	Meniscus Cutter		15-65320	15-65420	15-65520	● ●
	End Cutter			15-65520	15-65525	○ ●
	Full-Radius Resector		15-65330	15-65430	15-65530	○ ○
	Incisor		15-65340	15-65440	15-65540	● ●
	Cutter			15-65450		● ○

	Description	Ø 2,5 mm	Ø 3,4 mm	Ø 4,2 mm	Ø 5,5 mm	
	Round Burr			15-65460	15-65560	● ●
	Tapered Burr				15-65570	● ●
	Oval Burr			15-65480	15-65580	● ●

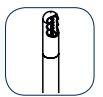

# Shaver blades for Aesculap



Length 130 mm, sterile, single use



	Description	Ø 2,5 mm	Ø 3,4 mm	Ø 4,2 mm	Ø 5,5 mm	
	Aggressive Full-Radius Resector		15-65310S	15-65410S	15-65510S	● ●
	Double Aggressive Full-Radius			15-65415S	15-65515S	○ ●
	Meniscus Cutter		15-65320S	15-65420S	15-65520S	● ●
	End Cutter			15-65425S	15-65525S	○ ●
	Full-Radius Resector		15-65330S	15-65430S	15-65530S	○ ○
	Incisor		15-65340S	15-65440S	15-65540S	● ●
	Cutter			15-65450S		● ○
	Round Burr			15-65460S	15-65560S	● ●
	Tapered Burr				15-65570S	● ●
	Oval Burr			15-65480S	15-65580S	● ●



Curved shaver blades for Aesculap



Length 130 mm, autoclavable, reusable





	Description	Ø 2,5 mm	Ø 3,4 mm	Ø 4,2 mm	Ø 5,5 mm	
	Aggressive Full-Radius Resector			15-65411		●●
	Full-Radius Resector			15-65431		○○
	Incisor			15-65441		●●

Curved shaver blades for Aesculap



Length 130 mm, sterile, single use



	Description	Ø 2,5 mm	Ø 3,4 mm	Ø 4,2 mm	Ø 5,5 mm	
	Aggressive Full-Radius Resector			15-65411S		●●
	Full-Radius Resector			15-65431S		○○
	Incisor			15-65441S		●●

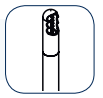

# Shaver blades for Aesculap

Length 210 mm, autoclavable, reusable





	Description	Ø 3,4 mm	Ø 4,2 mm	Ø 5,5 mm	
	Aggressive Full-Radius Resector	15-75310	15-75410	15-75510	● ●
	Meniscus Cutter	15-75320	15-75420	15-75520	● ●
	Full-Radius Resector	15-75330	15-75430	15-75530	○ ○
	Incisor	15-75340	15-75440	15-75540	● ●
	Round Burr			15-75550	● ●

### Shaver blades for Stryker formula



For small joints, length 80 mm, autoclavable, reusable



	Description	Ø 2,5 mm	Ø 3,5 mm	Ø 4,2 mm	Ø 5,5 mm	
	Aggressive Full-Radius Resector	15-66210				● ●
	Full-Radius Resector	15-66230				○ ○

### Shaver blades for Stryker formula





Length 130 mm, autoclavable, reusable



	Description	Ø 2,5 mm	Ø 3,5 mm	Ø 4,2 mm	Ø 5,5 mm	
	Aggressive Full-Radius Resector		15-66310	15-66410	15-66510	● ●
	Double Aggressive Full-Radius			15-66415	15-66515	○ ●
	Meniscus Cutter		15-66320	15-66420	15-66520	● ●
	End Cutter			15-66425	15-66525	○ ●
	Full-Radius Resector		15-66330	15-66430	15-66530	○ ○
	Incisor		15-66340	15-66440	15-66540	● ●
	Cutter			15-66450		● ○



	Description	Ø 2,5 mm	Ø 3,4 mm	Ø 4,2 mm	Ø 5,5 mm	
	Round Burr			15-66460	15-66560	● ●
	Tapered Burr				15-66570	● ●
	Oval Burr			15-66480	15-66580	● ●

# Shaver blades for Stryker formula



Length 130 mm, sterile, single use



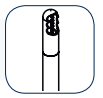

	Description	Ø 2,5 mm	Ø 3,4 mm	Ø 4,2 mm	Ø 5,5 mm	
	Aggressive Full-Radius Resector		15-66310S	15-66410S	15-66510S	● ●
	Double Aggressive Full-Radius			15-66415S	15-66515S	○ ●
	Meniscus Cutter		15-66320S	15-66420S	15-66520S	● ●
	End Cutter			15-66425S	15-66525S	○ ●
	Full-Radius Resector		15-66330S	15-66430S	15-66530S	○ ○
	Incisor		15-66340S	15-66440S	15-66540S	● ●
	Cutter			15-66450S		● ○
	Round Burr			15-66460S	15-66560S	● ●
	Tapered Burr				15-66570S	● ●
	Oval Burr			15-66480S	15-66580S	● ●



## Curved shaver blades for Stryker formula

Length 130 mm, autoclavable, reusable





	Description	Ø 2,5 mm	Ø 3,4 mm	Ø 4,2 mm	Ø 5,5 mm	
	Aggressive Full-Radius Resector			15-66411		● ●
	Full-Radius Resector			15-66431		○ ○
	Incisor			15-66441		● ●

## Curved shaver blades for Stryker formula



Length 130 mm, sterile, single use



	Description	Ø 2,5 mm	Ø 3,4 mm	Ø 4,2 mm	Ø 5,5 mm	
	Aggressive Full-Radius Resector			15-66411S		● ●
	Full-Radius Resector			16-68431S		○ ○
	Incisor			15-68441S		● ●

# Shaver blades for Stryker formula



Length 210 mm, autoclavable, reusable



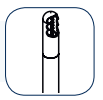

	Description	Ø 3,4 mm	Ø 4,2 mm	Ø 5,5 mm	
	Aggressive Full-Radius Resector	15-76310	15-76410	15-76510	● ●
	Meniscus Cutter	15-76320	15-76420	15-76520	● ●
	Full-Radius Resector	15-76330	15-76430	15-76530	○ ○
	Incisor	15-76340	15-76440	15-76540	● ●
	Round Burr			15-76560	● ●



## Shaver blades for Stryker SE-3 / SE-4 / SE-5

For small joints, length 80 mm, autoclavable, reusable



	Description	Ø 2,5 mm	Ø 3,4 mm	Ø 4,2 mm	Ø 5,5 mm	
	Aggressive Full-Radius Resector	15-68210				●●
	Full-Radius Resector	15-68230				○○

## Shaver blades for Stryker SE-3 / SE-4 / SE-5





Length 130 mm, autoclavable, reusable



	Description	Ø 2,5 mm	Ø 3,4 mm	Ø 4,2 mm	Ø 5,5 mm	
	Aggressive Full-Radius Resector		15-68310	15-68410	15-68510	●●
	Double Aggressive Full-Radius			15-68415	15-68515	○●
	Meniscus Cutter		15-68320	15-68420	15-68520	●●
	End Cutter			15-68425	15-68525	○●
	Full-Radius Resector		15-68330	15-68430	15-68530	○○
	Incisor		15-68340	15-68440	15-68540	●●
	Cutter			15-68450		●○



	Description	Ø 2,5 mm	Ø 3,4 mm	Ø 4,2 mm	Ø 5,5 mm	
	Round Burr			15-68460	15-68560	● ●
	Tapered Burr				15-68570	● ●
	Oval Burr			15-68480	15-68580	● ●

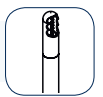

# Shaver blades for Stryker SE-3 / SE-4 / SE-5



Length 130 mm, sterile, single use



	Description	Ø 2,5 mm	Ø 3,4 mm	Ø 4,2 mm	Ø 5,5 mm	
	Aggressive Full-Radius Resector		15-68310S	15-68410S	15-68510S	● ●
	Double Aggressive Full-Radius			15-68415S	15-68515S	○ ●
	Meniscus Cutter		15-68320S	15-68420S	15-68520S	● ●
	End Cutter			15-68425S	15-68525S	○ ●
	Full-Radius Resector		15-68330S	15-68430S	15-68530S	○ ○
	Incisor		15-68340S	15-68440S	15-68540S	● ●
	Cutter			15-68450S		● ○
	Round Burr			15-68460S	15-68560S	● ●
	Tapered Burr				15-68570S	● ●
	Oval Burr			15-68480S	15-68580S	● ●

Curved shaver blades for Stryker SE-3 / SE-4 / SE-5



Length 130 mm, autoclavable, reusable





	Description	Ø 2,5 mm	Ø 3,4 mm	Ø 4,2 mm	Ø 5,5 mm	
	Aggressive Full-Radius Resector			15-68411		● ●
	Full-Radius Resector			15-68431		○ ○
	Incisor			15-68441		● ●

Curved shaver blades for Stryker SE-3 / SE-4 / SE-5



Length 130 mm, sterile, single use



	Description	Ø 2,5 mm	Ø 3,4 mm	Ø 4,2 mm	Ø 5,5 mm	
	Aggressive Full-Radius Resector			15-68411S		● ●
	Full-Radius Resector			15-68431S		○ ○
	Incisor			15-68441S		● ●

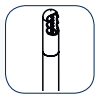

## Shaver blades for Stryker SE-3 / SE-4 / SE-5

Length 210 mm, autoclavable, reusable





	Description	Ø 3,4 mm	Ø 4,2 mm	Ø 5,5 mm	
	Aggressive Full-Radius Resector	15-78310	15-78410	15-78510	● ●
	Meniscus Cutter	15-78320	15-78420	15-78520	● ●
	Full-Radius Resector	15-78330	15-78430	15-78530	○ ○
	Incisor	15-78340	15-78440	15-78540	● ●
	Round Burr			15-78560	● ●

### Shaver blades for Arthronet



For small joints, length 80 mm, autoclavable, reusable



	Description	Ø 2,5 mm	Ø 3,4 mm	Ø 4,2 mm	Ø 5,5 mm	
	Aggressive Full-Radius Resector	15-69210				● ●
	Full-Radius Resector	15-69230				○ ○

### Shaver blades for Arthronet





Length 130 mm, autoclavable, reusable

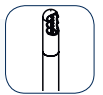

	Description	Ø 2,5 mm	Ø 3,4 mm	Ø 4,2 mm	Ø 5,5 mm	
	Aggressive Full-Radius Resector		15-69310	15-69410	15-69510	● ●
	Double Aggressive Full-Radius			15-69415	15-69515	○ ●
	Meniscus Cutter		15-69320	15-69420	15-69520	● ●
	End Cutter			15-69425	15-69525	○ ●
	Full-Radius Resector		15-69330	15-69430	15-69530	○ ○
	Incisor		15-69340	15-69440	15-69540	● ●
	Cutter			15-69450		● ○



	Description	Ø 2,5 mm	Ø 3,4 mm	Ø 4,2 mm	Ø 5,5 mm	
	Round Burr			15-69460	15-69560	● ●
	Tapered Burr				15-69570	● ●
	Oval Burr			15-69480	15-69580	● ●

# Shaver blades for Arthronet



Length 130 mm, sterile, single use



	Description	Ø 2,5 mm	Ø 3,4 mm	Ø 4,2 mm	Ø 5,5 mm	
	Aggressive Full-Radius Resector		15-69310S	15-69410S	15-69510S	● ●
	Double Aggressive Full-Radius			15-69415S	15-69515S	○ ●
	Meniscus Cutter		15-69320S	15-69420S	15-69520S	● ●
	End Cutter			15-69425S	15-69525S	○ ●
	Full-Radius Resector		15-69330S	15-69430S	15-69530S	○ ○
	Incisor		15-69340S	15-69440S	15-69540S	● ●
	Cutter			15-69450S		● ○
	Round Burr			15-69460S	15-69560S	● ●
	Tapered Burr				15-69570S	● ●
	Oval Burr			15-69480S	15-69580S	● ●

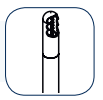



## Curved shaver blades for Arthronet



Length 130 mm, autoclavable, reusable





	Description	Ø 2,5 mm	Ø 3,4 mm	Ø 4,2 mm	Ø 5,5 mm	
	Aggressive Full-Radius Resector			15-69411		● ●
	Full-Radius Resector			15-96431		○ ○
	Incisor			15-69441		● ●

## Curved shaver blades for Arthronet



Length 130 mm, sterile, single use



	Description	Ø 2,5 mm	Ø 3,4 mm	Ø 4,2 mm	Ø 5,5 mm	
	Aggressive Full-Radius Resector			15-69411S		● ●
	Full-Radius Resector			15-69431S		○ ○
	Incisor			15-69441S		● ●



Shaver blades for Arthronet



Length 210 mm, autoclavable, reusable



	Description	Ø 3,4 mm	Ø 4,2 mm	Ø 5,5 mm	
	Aggressive Full-Radius Resector	15-79310	15-79410	15-79510	● ●
	Meniscus Cutter	15-79320	15-79420	15-79520	● ●
	Full-Radius Resector	15-79330	15-79430	15-79530	○ ○
	Incisor	15-79340	15-79440	15-79540	● ●
	Round Burr			15-79560	● ●

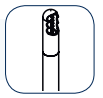

## Cleaning adapters Reinigungsadapter Adaptadores de limpieza

### Cleaning adapter

24-00017



### Cleaning adapter for REMA, Linvatec, Concept, Arthrex, Arthrex APS II, Atlantec

Reinigungsadapter für REMA, Linvatec, Concept, Arthrex, Arthrex APS II, Atlantec

Adaptador de limpieza para REMA, Linvatec, Concept, Arthrex, Arthrex APS II, Atlantec

### Cleaning adapter

24-00018



### Cleaning adapter for Dyonics EP-1 (smith&nephew)

Reinigungsadapter für Dyonics EP-1 (smith&nephew)

Adaptador de limpieza para Dyonics EP-1 (smith&nephew)

### Cleaning adapter for six interior sleeves

24-00019



### Cleaning adapter for six interior sleeves, REMA, Linvatec, Concept, Arthrex, Arthrex APS II, Atlantec

Reinigungsadapter für sechs Innenhülsen, REMA, Linvatec, Concept, Arthrex, Arthrex APS II, Atlantec

Adaptador de limpieza para seis vainas interiores, REMA, Linvatec, Concept, Arthrex, Arthrex APS II, Atlantec

### Cleaning brush

24-00016



### Cleaning brush, packed 10 each

Reinigungsbürste, pack 10 stck

Cepillo de limpieza, paquete con 10 piezas





# Electrodes Elektroden Electrodos

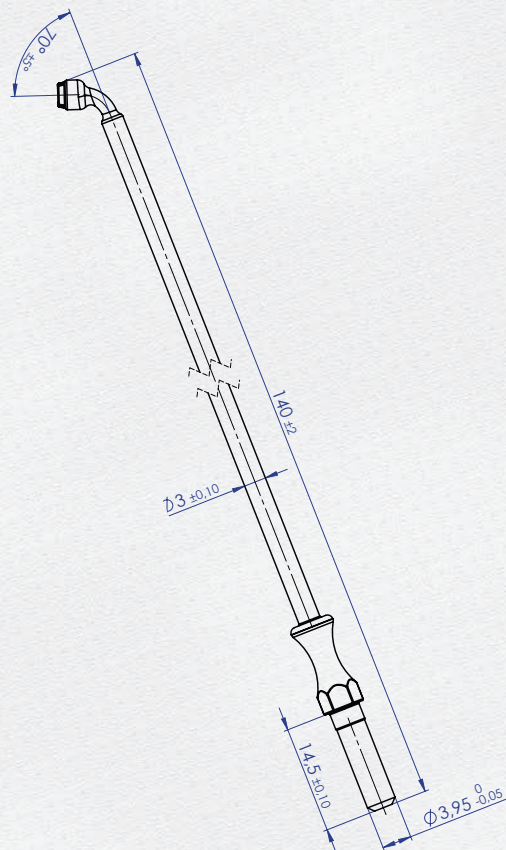

ARTHROSCOPY CATALOGUE

Konstrukteur / constructor  
gezeichnet / diseñado  
geprüft / verificado  
Toleranz / tolerancia

Datum / fecha	Name / nombre	Plan / plano
10-2015	cvd/jvd	1
10-2015	cvd	Maaßstab / escala 1:1
10-2015	mj	Abt. / acot. mm
		Artikel / artículo
		Artikel-Nr. / No. de artículo

- Steel



# Monopolar arthroscopic electrodes

## Monopolare Arthroskopieelektroden

### Electrodos monopolares para artroscopia

WIEDERVERWENDBAR · AUTOKLAVIERBAR 134°C

Reusable · Autoclavable 134°C

Reutilizable · Autoclavable 134°C

**Applicable for HF and RF generators**  
Für HF-und RF-Generatoren geeignet  
Para aplicaciones en generadores AF y RF

Umax : 4,3 kVp

Ø 4.0 mm Stecker Pin Conector

REF. No.

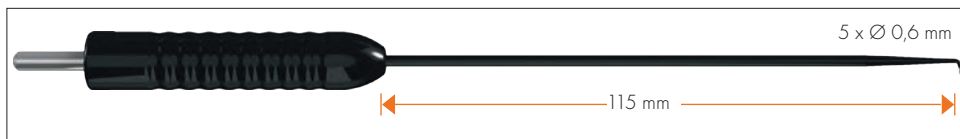

**15-17020** **Needle electrode, with handle 90° angular**  
Nadelelektrode, mit Handgriff, 90° abgewinkelt  
Electrodo de aguja, con mango angular 90°



**15-17021** **Needle electrode, with handle 90° angular**  
Nadelelektrode, mit Handgriff, 90° abgewinkelt  
Electrodo de aguja, con mango angular 90°



**15-17022** **Knife electrode, with handle 90° angular**  
Messerelektrode, mit Handgriff, 90° abgewinkelt  
Electrodo de cuchillo, con mango angular 90°



**15-17023** **Button electrode, with handle 90° angular**  
Tastelektrode, mit Handgriff, 90° abgewinkelt  
Electrodo de botón, con mango angular 90°



**15-17024** **Ball electrode, with handle**  
Kugelelektrode, mit Handgriff  
Electrodo de bola, con mango

**Cable for instruments**  
Kabel für Instrumente Ø 4 mm  
Cable para instrumentos

**HF - Generator conection**  
HF - Geräteseite  
Conexión de generador de AF

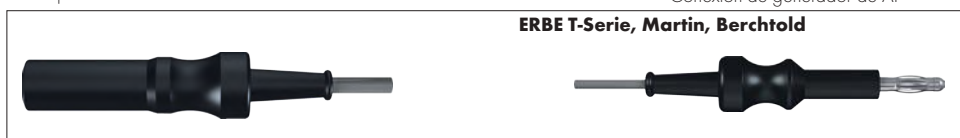

15-17000.40 3,0 mm  
15-17000.41 5,0 mm

**Cable for instruments**  
Kabel für Instrumente Ø 4 mm  
Cable para instrumentos

**HF - Generator conection**  
HF - Geräteseite  
Conexión de generador de AF



15-17000.42 3,0 mm  
15-17000.43 5,0 mm



# Monopolar arthroscopic electrodes

## Monopolare Arthroskopieelektroden

Electrodos monopolares para artroscopia

**WIEDERVERWENDBAR · AUTOKLAVIERBAR 134°C**

Reusable · Autoclavable 134°C

Reutilizable · Autoclavable 134°C

**Applicable for HF and RF generators**  
Für HF-und RF-Generatoren geeignet  
Para aplicaciones en generadores AF y RF

U<sub>max</sub> : 4,3 kVp

**Ø 4,0 / Ø 2,4 mm Stecker Pin Conector**



E.g. ERBE,  
Bowa-  
Berchthold-  
compatible



Ø 4,0 mm

**Stecker**  
Pin  
Conector

International,  
e.g. Arthrex-  
Linvatec-  
compatible



Ø 2,4 mm

REF. No.

REF. No.

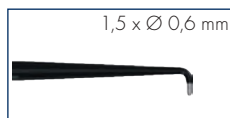

1,5 x Ø 0,6 mm

15-17030

15-17040

**Needle electrode, 90° angular**

Nadelektrode, 90° gebogen  
Electrodo de aguja, 90° angular

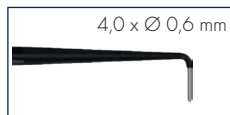

4,0 x Ø 0,6 mm

15-17031

15-17041

**Hollow ball electrode, 90° angular**

Nadelektrode, 90° gebogen  
Electrodo hueco de bola, 90° angular

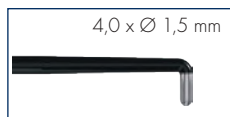

4,0 x Ø 1,5 mm

15-17032

15-17042

**Button electrode**

Tastelektrode  
Electrodo de botón

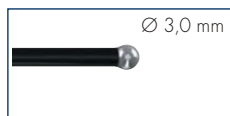

Ø 3,0 mm

15-17033

15-17043

**Ball electrode**

Kugelelektrode  
Electrodo de bola



15-17034

15-17044

**Hollow ball electrode**

Hohlkugelelektrode  
Electrodo hueco de bola



15-17035

15-17045

**Flat electrode**

Flächenelektrode  
Electrodo plano



15-17036

15-17046

**Brush electrode**

Bürstenelektroden  
Electrodo de cepillo

## Electrode handle with two pushbuttons

### Elektrodenhandgriffe mit Doppeltaster

Mango para electrodos con dos teclas

WIEDERVERWENDBAR · AUTOKLAVIERBAR 134°C

Reusable · Autoclavable 134°C

Reutilizable · Autoclavable 134°C

U<sub>max</sub> : 4,3 kVp



### Ø 4,0 mm Stecker Pin Conector

REF. No.

Länge  
Length  
Longitud

<p>ERBE kompatibel compatible compatible</p> 
<p>Berchtold/Integra kompatibel compatible compatible</p> 
<p>3 Pole 3 Poles 3 Polos</p> 
<p>Erbe T-Modell</p> 

15-17000.20

3,0 m

**Handle for Ø4 mm electrodes plug, cable integrated**

15-17000.21

5,0 m

HF-Handgriff für Ø4 mm Elektroden Anschluss, Kabel integriert  
Mango para conector de electrodos de Ø4 mm, cable integrado

15-17000.22

3,0 m

**Handle for Ø4 mm electrodes plug, cable integrated**

15-17000.23

5,0 m

HF-Handgriff für Ø4 mm Elektroden Anschluss, Kabel integriert  
Mango para conector de electrodos de Ø4 mm, cable integrado

15-17000.24

3,0 m

**Handle for Ø4 mm electrodes plug, cable integrated**

15-17000.25

5,0 m



HF-Handgriff für Ø4 mm Elektroden Anschluss, Kabel integriert  
Mango para conector de electrodos de Ø4 mm, cable integrado

15-17000.26

**Handle for Ø4 mm electrodes plug, cable integrated**

HF-Handgriff für Ø4 mm Elektroden Anschluss, Kabel integriert  
Mango para conector de electrodos de Ø4 mm, cable integrado

### Ø 2,4 mm Stecker Pin Conector

<p>ERBE kompatibel compatible compatible</p> 
<p>Berchtold/Integra kompatibel compatible compatible</p> 
<p>3 Pole 3 Poles 3 Polos</p> 

15-17000.27

3,0 m

**Fingerswitch for Ø2.4 mm electrodes plug, cable integrated**

15-17000.28

5,0 m

HF-Handgriff für Ø2,4 mm Elektroden Anschluss, Kabel integriert  
Interruptor de dedo para conector de electrodos de Ø2.4 mm, cable integrado

15-17000.30

3,0 m

**Fingerswitch for Ø2.4 mm electrodes plug, cable integrated**

15-17000.31

5,0 m

HF-Handgriff für Ø2,4 mm Elektroden, Anschluss Kabel integriert  
Interruptor de dedo para conector de electrodos de Ø2.4 mm, cable integrado

15-17000.32

3,0 m

**Fingerswitch for Ø2.4 mm Telectrodes plug, cable integrated**

15-17000.33

5,0 m

HF-Handgriff für Ø2,4 mm Elektroden Anschluss, Kabel integriert  
Interruptor de dedo para conector de electrodos de Ø2.4 mm, cable integrado



# Bipolar arthroscopic electrodes

## Bipolare Arthroskopieelektroden

Electrodos bipolares para artroscopia

**WIEDERVERWENDBAR · AUTOKLAVIERBAR 134°C**

Reusable · Autoclavable 134°C

Reutilizable · Autoclavable 134°C

**Applicable for HF and RF generators**  
Für HF-und RF-Generatoren geeignet  
Para aplicaciones en generadores AF y RF

U<sub>max</sub> : 1,0 kVp

Ø 1,6 / Ø 12,0 mm Stecker Pin Conector



**Longversion**  
Langversion 170 mm  
Versión Larga

**Shortversion**  
Kurzversion 115 mm  
Versión Corta



REF. No.

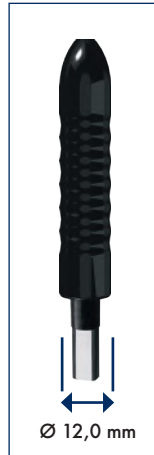

REF. No.

15-17006	15-17061		<b>Bipolar vaporisation electrode "Phazer" 90° curved</b> Bipolare Vaporisationselektrode "Phazer" 90° gebogen Electrodo bipolar para vaporización "Phazer" curvado 90°
170 mm	115 mm		
15-17001	15-17011		<b>Bipolar vaporisation electrode "Phazer" 70° curved</b> Bipolare Vaporisationelektrode "Phazer" 70° gebogen Electrodo bipolar para vaporización "Phazer" curvado 70°
170 mm	115 mm		
15-17003	15-17013	1,5 mm x Ø 0,6 mm 	<b>Bipolar hook electrode</b> Bipolare Hakenelektrode Electrodo bipolar de gancho
170 mm	115 mm		
	15-17015		<b>Bipolar loop electrode "Cobra"</b> Bipolare Schlingenelektrode "Cobra" Electrodo bipolar de lazo "Cobra"
	115 mm		
15-17007			<b>Bipolar vaporization electrode 90°</b> Bipolare Vaporisationselektrode 90° Electrodo bipolar para vaporización 90°
170 mm			



**HF - Cables, Bipolar**  
HF - Kabel, Bipolar  
Cables de AF, Bipolar

**WIEDERVERWENDBAR · AUTOKLAVIERBAR 134°C**











Reusable · Autoclavable 134°C

Reutilizable · Autoclavable 134°C

**U<sub>max</sub> : 800 kVp**

**Instrument connection**  
Instrumentenseite  
Conexión del instrumento

**HF - Generator conection**  
HF - Geräteseite  
Conexión de generador de AF

		REF. No.	Length Länge Longitud
<p><b>Bipolar forceps cable</b> Pinzettenkabel bipolar Cable para pinzas bipolares</p>  <p>ERBE, Bowa, Berchtold, Bissinger</p>	<p><b>ERBE</b></p> 	15-17000.9	5,0 m
	<p><b>Berchtold, KLS Martin</b></p> 	15-17000.10	5,0 m
	<p><b>US 2 Pol</b></p> 	15-17000.1	5,0 m
	<p><b>Intern. 2 pol</b></p> 	15-17000.12	5,0 m
<p><b>Bipolar forceps cable</b> Pinzettenkabel bipolar Cable para pinzas bipolares</p>  <p>ERBE, Bowa, Berchtold, Bissinger</p>	<p><b>ERBE</b></p> 	15-17000.1 15-17000.2	3,0 m 5,0 m
	<p><b>Berchtold, KLS Martin</b></p> 	15-17000.3 15-17000.4	3,0 m 5,0 m
	<p><b>US 2 Pol</b></p> 	15-17000.5 15-17000.6	3,0 m 5,0 m
	<p><b>Intern. 2 Pol</b></p> 	15-17000.7 15-17000.8	3,0 m 5,0 m



# Complements Zubehör Complementos



## Fibre light cable

### Fiberlichtkabel

Cable conductor de luz



#### Fibre Light cable, autoclavable at 2,3 bar (134°C)

Fiber-Lichtleitkabel, autoklavierbar bei 2,3 bar (134°C)

Cable conductor de luz, autoclavable a 2,3 bares (134° C)

Equipment adapter Geräte-Adapter Adaptador para equipo	Endoscope adapter Endoskop-Adapter Adaptador para endoscopio	Ø mm	Length Länge 1800 mm Longitud	Length Länge 2300 mm Longitud	Length Länge 13000 mm Longitud
REMA, Storz, Aesculap	REMA, Storz, Aesculap	3,5	31-00150	31-00151	31-00152
REMA, Storz, Aesculap	REMA, Storz, Aesculap	4,8	31-00200	31-00201	31-00202
Winter, Ibe	REMA, Storz, Aesculap	3,5	31-00160	31-00161	31-00162
Winter, Ibe	REMA, Storz, Aesculap	4,8	31-00210	31-00211	31-00212
Wolf, HSW	Wolf, HSW	3,5	31-00170	31-00171	31-00172
Wolf, HSW	Wolf, HSW	4,8	31-00220	31-00221	31-00222
ACM, British	ACM, British	3,5	31-00180	31-00181	31-00182
ACM, British	ACM, British	4,8	31-00230	31-00231	31-00232

#### High Power Light cables for light sources with high performance, autoclavable at 2,3 bar (134°C)

Hochleistungslichtkabel für Lichtquellen mit hoher Leistung, autoklavierbar bei 2,3 bar (134°C)

Cables conductores de luz High Power para fuentes de luz de alto desempeño, autoclavable a 2,3 bares (134° C)

Equipment adapter Geräte-Adapter Adaptador para equipo	Endoscope adapter Endoskop-Adapter Adaptador para endoscopio	Ø mm	Length Länge 1800 mm Longitud	Length Länge 2300 mm Longitud	Length Länge 13000 mm Longitud
REMA, Storz, Aesculap	REMA, Storz, Aesculap	3,5	31-00540	31-00541	31-00542
REMA, Storz, Aesculap	REMA, Storz, Aesculap	4,8	31-00500	31-00501	31-00502
Winter, Ibe	REMA, Storz, Aesculap	3,5	31-00550	31-00551	31-00552
Winter, Ibe	REMA, Storz, Aesculap	4,8	31-00510	31-00511	31-00512
Wolf, HSW	Wolf, HSW	3,5	31-00560	31-00561	31-00562
Wolf, HSW	Wolf, HSW	4,8	31-00520	31-00521	31-00522
ACM, British	ACM, British	3,5	31-00570	31-00571	31-00572
ACM, British	ACM, wBritish	4,8	31-00530	31-00531	31-00532



## Arthroscopy leg holder Arthroskopie-Beinhalter Sujetador de pierna

### Arthroscopy leg holder 19-42405



### Arthroscopy leg holder Arthroskopie-Beinhalter Sujetador de pierna para Artroscopia

### Clamping device "VARIO-FIX" 19-42411



### Clamping device "VARIO-FIX" vertically and horizontally adjustable by 60° OP-Kloben "VARIO-FIX" Vertikal und horizontal um 60° verstellbar Dispositivo de sujeción "VARIO-FIX" ajustable vertical y horizontalmente 60°

**The REMA leg holder is permeable to x-rays in the horizontal as well as in the vertical way.**

**Standard Exsanguination Cuffs can be inserted into the holder.**

**„VARIO-FIX“, adjustable laterally in both directions by 60°. These leg holders are suitable for all fixing devices of systems manufactured by other companies.**

Der REMA-Arthroskopie-Beinhalter ist sowohl horizontal als auch vertikal durchlässig für Röntgenstrahlen.

Standard-Blutleermanschetten können in die Halterung mit eingelegt werden.

„VARIO-FIX“, in beiden Richtungen um 60° verstellbar. Die Beinhalter passen in alle Halterungen von im OP vorhandenen Fremdsystemen.

El sujetador de pierna REMA, es permeable a los rayos X, tanto en posición horizontal como en vertical.

Los brazaletes de exanguinación estándar pueden ser insertados en el sujetador.

„VARIO-FIX“, ajustable lateralmente en ambas direcciones 60°. Estos sujetadores son adecuados para todos los dispositivos de fijación de sistemas manufacturados por otras compañías.

**Exsanguinator**  
Blutleermanschette  
Exsanguinador

**Exsanguinator**  
95-09990

**Exsanguinator**  
Blutleermanschette  
Exsanguinador



**The Exsanguinator can be used for the hand or the foot.**

Die Blutleermanschette (Exsanguinator) kann für den Arm sowie für das Bein benutzt werden.

El Exsanguinator se puede utilizar para la mano o el pie.

**Method of Application**

**1. The patient's limb is elevated for 1 minute and then the exsanguinator is rolled onto the operators arm until his hand comes out the other end.**

**2. The operator then grasps the patient's hand or foot, enclosing all digits.**

**3. While pulling gently on the limb the exsanguinator is rolled onto it.**

**4. The exsanguinator is rolled up to the level of a padded tourniquet cuff. For adult legs assistance may be required to roll the sleeve onto the wider part of the thigh.**

**5. Tourniquet inflated.**

**6. Exsanguinator rolled off the limb.**

**Anwendungsverfahren**

1. Das Glied des Patienten wird 1 Minute lang angehoben, und anschließend wird der Exsanguinator auf den Arm des Bedieners gerollt, bis seine Hand am anderen Ende hervortritt.

2. Er ergreift dann die Hand oder den Fuß des Patienten, wobei alle Finger bzw. Zehen eingeschlossen werden.

3. Unter behutsamen Ziehen am Glied wird den Exsanguinator auf es gerollt.

4. Der Exsanguinator wird bis zu einer gepolsterten Tourniquetmanschette hochgerollt. Bei Beinen von Erwachsenen ist u. U. Hilfestellung erforderlich, um den Exsanguinator auf den breiteren Teil des Oberschenkels zu rollen.

5. Tourniquet aufgeblasen

6. Exsanguinator vom Glied heruntergerollt.

**Método de aplicación**

1. Se eleva la extremidad del paciente durante 1 minuto. A continuación se enrolla el Exsanguinator sobre el brazo del operario clínico hasta que su mano sobresalga de su extremo opuesto.

2. El operario aprieta la mano o el pie del paciente, rodeando todos los dedos.

3. Estirando suavemente la extremidad, enrollar el Exsanguinator sobre ella.

4. Se enrolla el Exsanguinator hasta la altura del manguito acolchado de torniquete. Para las piernas de personas adultas, puede precisarse de ayuda para enrollar el Exsanguinator sobre la parte más ancha del muslo.

5. Se infla el manguito acolchado del torniquete.

6. Se retira el Exsanguinator de la extremidad.





---

---

---

---

---





## Notes

A large area of the page is filled with horizontal dotted lines, providing space for handwritten notes.



Authorized Dealer:



**REMA**  
**SURGERY**

**REMA Medizintechnik GmbH**

In Breiten 10 D-78589 Dürbheim  
Tuttlingen Germany

Tel: +49 74 24 981053-0

Fax: +49 74 24 981053-99

E-Mail: [info@rema-surgery.de](mailto:info@rema-surgery.de)

Version: 07 - 2016

Item No.: 001.2016

